

SPIRIT M-Series

Professional Two-way Radio
Owner's Manual



MOTOROLA

Copyright Information

The Motorola products described in this manual may include copyrighted Motorola programs stored in semiconductor memories or other media. Laws in the United States and other countries preserve for Motorola, certain exclusive rights for copyrighted computer programs, including the exclusive right to copy or reproduce in any form, the copyrighted Motorola programs. Accordingly, any copyrighted Motorola computer programs contained in the Motorola products described in this manual may not be copied or reproduced in any manner without the express written permission of Motorola. Furthermore, the purchase of Motorola products shall not be deemed to grant either directly or by implication, estoppel, or otherwise, any license under the copyrights, patents or patent applications of Motorola, except for the normal non-exclusive royalty free license to use that arises by operation of law in the sale of a product.

To help you easily locate important information in this manual, the following icons are used to signal warnings and cautions.

Here's what the symbols mean:

CAUTION

Indicates a potentially hazardous situation which, if not avoided, may result in minor or moderate injury.

WARNING

Indicates a potentially hazardous situation which, if not avoided, may result in death or serious injury.

Please see pages 16 and 17 for complete information.



MOTOROLA

TABLE OF CONTENTS

FCC Licensing Information	2
Getting Started	
Your New Radio	3
Contents Of Package	3
Spirit M-Series Radio.....	4
To Attach/Remove Antenna	5
To Attach/Remove Belt Clip	5
Batteries.....	6
Low Battery Alert.....	6
To Install/Remove Batteries	6
To Charge Battery With Charger Adapter	7
To Charge Battery With 10 Hour Desktop Charger (Optional)	7
Programming	
Understanding Frequencies and Codes	8
To Change Frequency and Code Settings	8
1 Channel Models	8
2 And 4 Channel Models	9
Frequency Tables.....	10
Code Tables	11
Operations	
Turn The Radio On/Off.....	12
Adjust The Volume	12
To Send/Receive Messages	12
Time-out Timer	12
Scan (Optional).....	12
Built-In VOX (Optional).....	13
Accessories.....	13
Other Information	
Troubleshooting.....	14
Radio Care.....	15
Spirit Talk Range.....	15
Safety Information	16-17
One Year Limited Warranty	18-19
Recycling Of Nickel-Cadmium Batteries	20

LICENSING

FCC Licensing Information

Your Motorola radio operates on FM radio communication frequencies and is subject to the Rules and Regulations of the Federal Communications Commission (FCC). The FCC requires that all operators using Private Land Mobile frequencies obtain a radio license before operating their equipment. Application for your FCC license is made on FCC Form 600 and schedules D, E, and G.

To have the forms faxed to you by the FCC, call the FCC Fax-On-Demand system at 1-202-418-0177 from your Fax machine and request document 000600 for all forms and instructions.

To have the forms mailed to you, call the FCC forms hotline at:

1-800-418-FORM

(1-800-418-3676)

For questions concerning the license application, contact the FCC at:

1-888-CALL-FCC

(1-888-225-5322)

Before filling out your application, you must decide which frequency(ies) you can operate on. See frequency tables on page 10.

For questions on determining your radio frequency, please call Motorola Product Services at:

1-800-448-6686

GETTING STARTED

Your New Radio

Thank you for purchasing a Motorola Spirit radio. Your radio is a product of Motorola's 50 years of experience as a world leader in the designing and manufacturing of communications equipment. With proper care and use, your Motorola radio should give you years of reliable communication.

Please read this manual carefully to ensure you know how to properly operate the radio before use.



1



2



3

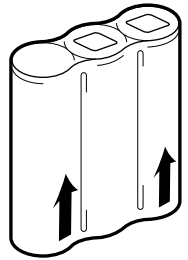

4

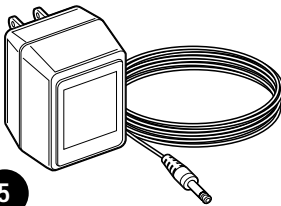

5

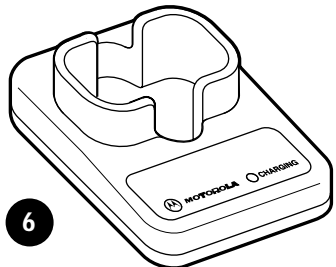

6

Contents of Package

1. Radio (1 channel model shown)
2. Antenna (UHF shown)
3. Belt Clip
4. Ni-Cad Battery Pack
5. 10 Hour Charger Adapter
6. 10 Hour Desktop Charger (Optional)
Literature (Not shown)
Owner's Manual
Quick Reference Guide
Warranty Card

The 10 Hour Desktop Charger is optional and may not be included in your package.

GETTING STARTED

Spirit M-Series Radio

1. Antenna
2. Push-To-Talk Button
3. Monitor Button
4. Microphone
5. Battery Cover
6. Battery Cover Latches
7. Speaker
8. On-Off/Volume Knob
9. Transmit Light
10. Accessory Jack
11. Accessory Jack Cover

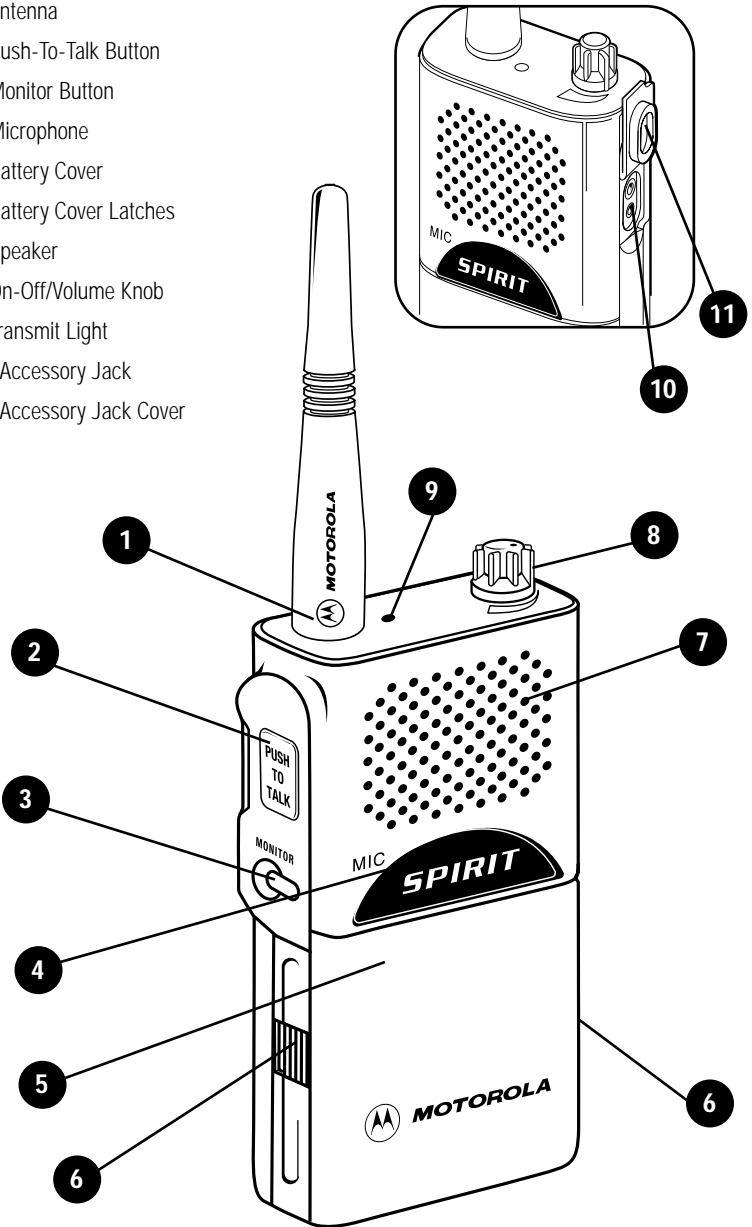

To Attach/Remove Antenna

To attach the antenna, rotate the antenna clockwise onto the top of the radio until hand tight. Reverse to remove. Fig. A

Note: The antenna should always be installed when operating the radio. Operating the radio without an antenna greatly reduces the range of the radio.

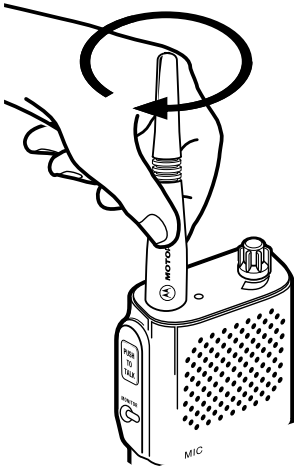

FIG. A

To Attach/Remove Belt Clip

1. Align the belt clip to the mounting rails on the back of the radio. Fig. B
2. Push the belt clip down until it clicks into place.
3. To remove, pull tab on belt clip away from radio to release. Fig. C
4. Slide belt clip up and off.

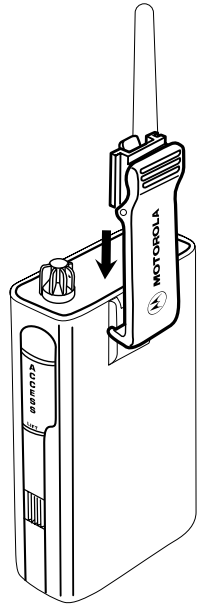

FIG. B

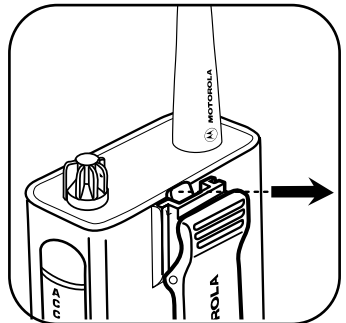

FIG. C

GETTING STARTED

Batteries

The Ni-Cad battery ships uncharged, it must be fully charged for 16 hours before use (first charge only). It is recommended that only Motorola batteries and chargers are used with the radio.

The Ni-Cad rechargeable battery pack will provide approximately 8 hours of operation for your radio with normal use (5% sending messages, 5% receiving messages and 90% in standby mode).

Low Battery Alert

When the battery is low, the radio will beep:

- 3 to 4 seconds after turning power on
- Every 10 minutes in standby mode
- After release of the Push-To-Talk button

Recharge the battery pack immediately to avoid interrupted use.

Note: Remove battery pack before storing your radio for extended periods. Batteries may corrode over time if left in radio and can cause permanent damage to your radio.

To Install/Remove Batteries

Note: Radio must be OFF before installing/removing battery.

1. Push back both battery cover latches until you see the orange tabs.
2. Slide battery cover down and lift to remove. Fig. D

To replace/install battery, insert the battery pack with arrows pointing towards the top of the radio. Fig. E

3. Replace battery cover and lock latches.
4. To remove battery, remove cover, turn the radio over and tap the battery end of the radio against the palm of your hand. The battery will drop into your hand. Fig. F

Note: Do not remove the plastic wrap from the battery pack. This will permanently damage the battery.

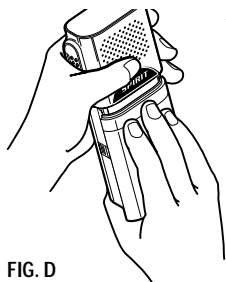

FIG. D

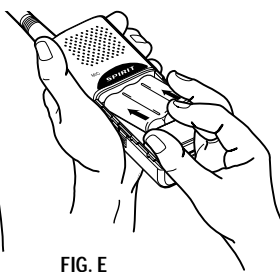

FIG. E

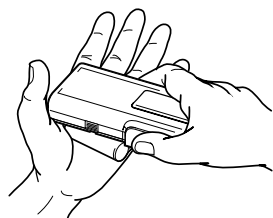

FIG. F

To Charge Battery With Charger Adapter

1. Turn the radio off.
2. Lift accessory cover and plug the Charger Adapter firmly into the small jack (lower hole). Fig. G
3. Plug the charger into an electric outlet. The light on the charger will glow continuously if charging properly.
4. Allow 10 hours for the battery to fully charge.

Notes:

- For optimum battery life, the battery should not be left charging for prolonged periods after reaching full charge. Charging the battery over the weekend is acceptable.
- Do not transmit while radio is charging. Transmitting while radio is charging can cause the radio transmitter or the charger to operate improperly.
- Turn radio off when charging. If radio is on while charging, at least twice as much time is required to charge the battery.

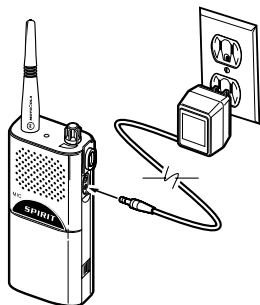

FIG. G

To Charge Battery With 10 Hour Desktop Charger

Note: The Desktop Charger is optional and may not be included in your package.

1. Connect Desktop Charger and Charger Adapter. Fig. H
2. Charge the battery while inside the radio by placing the radio in the Desktop Charger with radio facing towards you.
You can also charge the battery by removing battery from radio and placing it in Desktop Charger. Silver contacts must face down and arrow points toward front of charger. Fig. H
3. The light on top of the Desktop Charger will glow continuously when radio / battery is inserted. If light does not come on, check radio / battery is properly inserted and check battery/ charger contacts to be sure they are clean. The light will continue to glow until the radio / battery is removed from Desktop Charger.
4. Allow 10 hours for the battery to fully charge.

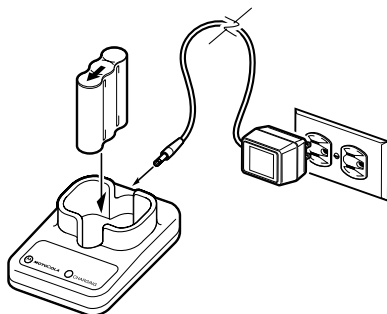

FIG. H

PROGRAMMING

Understanding Frequencies and Codes

Frequencies:

Your radio operates on a group of frequencies (see page 10 for complete listing). You access frequency(ies) through radio channel(s). You can operate on any of your radio's frequencies, but each must be licensed through the FCC (see page 2).

To understand the difference between frequencies and channels, think of channels as pre-set buttons on your car stereo and the frequencies as the many radio stations available. You can select and save different stations (frequencies) to pre-set buttons (channels) for easy access.

Interference Eliminator Codes:

Codes filter out static, noise and unwanted chatter on radio channels (see page 11 for complete listing). When you operate on a frequency with a code set, you block out most interference on the frequency. This allows you to communicate with less interference than when operating without a code. Remember, since radio frequencies can be monitored, codes will not make your conversations private.

- **For compatibility with radios that do not have codes, the radio can be set to Code "Off" in the programming mode. See following instructions.**

IMPORTANT

To talk to others in your group all radios must be set to the same channel and code.

There are settings programmed into your radio for frequencies and codes. If it is necessary to confirm settings or to change them for licensing purposes, the radio will audibly guide you through a series of programming steps. If you have questions, please call Motorola Product Services at 1-800-448-6686.

To Change Frequency and Code Settings

1 Channel Models

1. Hold Push-To-Talk button down while turning radio on. Fig. J
 - 🔊 *Radio announces current frequency setting. Example: "frequency one"*
2. Press Push-To-Talk button to scroll through frequencies. Fig. K
 - 🔊 *Radio announces each frequency as you scroll. Example: "two...three..."*
3. Release Push-To-Talk when you have reached desired frequency.
4. Press Monitor button to select and save new frequency setting. Fig. L
 - 🔊 *Radio announces current code setting. Example: "code two nine"*
5. Press Push-To-Talk to scroll through codes.
 - 🔊 *Radio announces each code as you scroll. Example: "three zero...three one"*
6. Release Push-To-Talk when you have reached desired code.
7. Press Monitor button to select and save new code setting.
 - 🔊 *Radio "beeps" to indicate it has exited programming and is ready for use.*

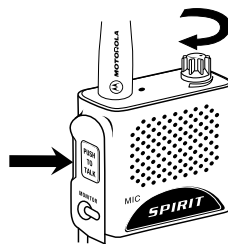

FIG. J 1 Channel Model

2 and 4 Channel Models

1. Turn Channel Selector knob to channel 1.
Fig. I

2. Hold Push-To-Talk button down while turning radio on. Fig. J

🔊 *Radio announces current frequency setting for that channel. Example: "frequency one"*

3. Press Push-To-Talk button to scroll through frequencies.

🔊 *Radio announces each frequency as you scroll. Example: "two...three..."*

4. Release Push-To-Talk when you have reached desired frequency.

5. Turn Channel Selector knob to channel 2 and repeat steps 3 and 4 above.

4 Channel Models: Repeat to set channels 3 and 4.

6. Press Monitor button to select and save new frequency setting. Fig. L

🔊 *Radio announces current code setting. Example: "code two nine"*

7. Press Push-To-Talk button to scroll through codes.

🔊 *Radio announces each code as you scroll. Example: "three zero...three one"*

8. Release Push-To-Talk when you have reached desired code.

9. Press Monitor button to select and save new code setting.

🔊 *Radio "beeps" to indicate it has exited programming and is ready for use.*

Channel Selector Knob

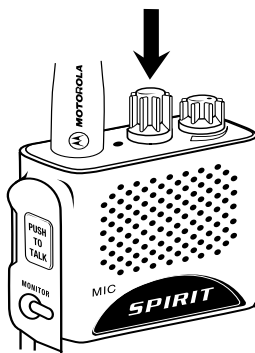

FIG. I 2 or 4 Channel Model

Notes:

- To use this radio with other Spirit models, please see tables on pages 10-11.
- Code numbers with two digits (10-38) will be announced "one zero...three eight".
- You can only scroll forward when selecting frequency or code.
- When you are changing frequency or code, you can not send messages.
- The Code setting applies to all channels. You can not select a different code for each channel.
- For Radios With Scan: The radio will sound a warning tone if you accidentally switch to the "s" position while programming. See page 12 for more information.

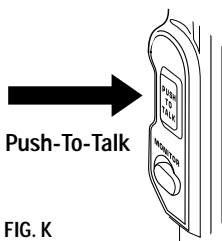

FIG. K

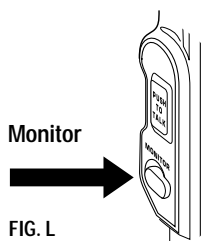

FIG. L

FREQUENCY TABLES

Spirit M-Series Radio Frequencies

Your Spirit M-Series radio operates on the following frequencies.

Spirit M-Series UHF*

Frequency Number	Frequency MHz	Frequency Color
1	464.5000	Brown
2	464.5500	Yellow
3	467.7625	J
4	467.8125	K
5	467.8500	Silver Star
6	467.8750	Gold Star
7	467.9000	Red Star
8	467.9250	Blue Star

Spirit M-Series VHF**

Frequency Number	Frequency MHz	Frequency Color
1	151.6250	Red
2	151.9550	Purple
3	154.5700	Blue
4	154.6000	Green

*Series number begins with MU.

**Series number begins with MV.

Your M-Series UHF radio is pre-set to these frequency(ies):

Channel 1: Frequency 2

Channel 3: Frequency 5

Channel 2: Frequency 8

Channel 4: Frequency 6

Your M-Series VHF radio is pre-set to these frequency(ies):

Channel 1: Frequency 3

Channel 3: Frequency 1

Channel 2: Frequency 4

Channel 4: Frequency 2

New FCC licensees should not use frequencies 467.7625 MHz (J) and 467.8125 MHz (K).

Call 1-888-CALL-FCC (1-888-225-5322) with your questions.

Other Spirit Radio Frequencies

To program other Spirit radios to the same frequency(ies) as your M-Series radio, please use the following tables to match frequency settings:

1 AND 2 WATT MODELS

1 Channel UHF Spirit Models[†]

Freq. MHz	Color	Dip Switch Positions			
		S1	S2	S3	S4
464.5000	Brown	OFF	OFF	ON	ON
464.5500	Yellow	ON	ON	OFF	OFF
467.7625	J	ON	ON	ON	ON
467.8125	K	OFF	OFF	OFF	OFF
467.8500	Silver Star	ON	ON	ON	OFF
467.8750	Gold Star	OFF	OFF	OFF	ON
467.9000	Red Star	ON	OFF	OFF	OFF
467.9250	Blue Star	OFF	ON	ON	ON

1 Channel VHF Spirit Models^{††}

Freq. MHz	Color	Dip Switch Positions			
		S1	S2	S3	S4
151.6250	Red	ON	ON	OFF	OFF
151.9550	Purple	OFF	OFF	ON	ON
154.5700	Blue	OFF	OFF	OFF	OFF
154.6000	Green	ON	ON	ON	ON

2 Channel UHF Spirit Models[†]

Channel 1		Channel 2		Dip Switch Positions			
Freq. MHz	Color	Freq. MHz	Color	S1	S2	S3	S4
464.5500	Yellow	464.5000	Brown	OFF	OFF	OFF	OFF
467.7625	J	464.5000	Brown	OFF	ON	OFF	OFF
464.5500	Yellow	467.8125	K	OFF	OFF	ON	OFF
467.7625	J	467.8125	K	OFF	ON	ON	OFF
467.8500	Silver	467.8125	K	OFF	OFF	OFF	ON
464.5500	Yellow	467.9250	Blue Star	OFF	ON	OFF	ON
467.7625	J	467.9250	Blue Star	OFF	OFF	ON	ON
467.8500	Silver	467.9250	Blue Star	OFF	ON	ON	ON

2 Channel VHF Spirit Models^{††}

Channel 1		Channel 2		Dip Switch Positions			
Freq. MHz	Color	Freq. MHz	Color	S1	S2	S3	S4
151.6250	Red	154.6000	Green	OFF	OFF	OFF	OFF
151.6250	Red	154.5700	Blue	OFF	ON	OFF	OFF
151.6250	Red	151.9550	Purple	OFF	OFF	ON	OFF
154.6000	Green	154.5700	Blue	OFF	ON	ON	OFF

[†]Series number begins with SU or states Spirit Pro +.

^{††}Series number begins with SV, AV, PC, CS, CV or states Spirit 2-Way or Spirit Pro.

4 AND 5 WATT MODELS

Spirit UHF Model SU42

Channel	Frequency MHz	Color
1	464.5000	Brown
2	464.5500	Yellow

Spirit VHF Model SV52

Channel	Frequency MHz	Color
1	151.6250	Red
2	151.9550	Purple

CODE TABLES

M-Series Radios

Code No.	Freq. Hz
1	67.0
2	71.9
3	74.4
4	77.0
5	79.7
6	82.5
7	85.4
8	88.5
9	91.5
10	94.8
11	97.4
12	100.0
13	103.5
14	107.2
15	110.9
16	114.8
17	118.8
18	123.0
19	127.3
20	131.8
21	136.5
22	141.3
23	146.2
24	151.4
25	156.7
26	162.2
27	167.9
28	173.8
29	179.9
30	186.2
31	192.8
32	203.5
33	210.7
34	218.1
35	225.7
36	233.6
37	241.8
38	250.3
OFF	None

Other Spirit Radios

1 & 2 Watt Models

Code No.	Freq. Hz	Dip Switch Positions							
		S1	S2	S3	S4	S5	S6	S7	S8
XZ	67.0	D	D	D	D	D	D	U	U
XA	71.9	U	D	D	D	D	D	U	U
WA	74.4	D	D	D	D	D	U	U	U
XB	77.0	U	U	D	D	D	D	U	U
WB	79.7	D	D	D	D	U	D	U	U
YZ	82.5	U	D	D	D	D	U	U	U
YA	85.4	D	D	D	D	U	U	U	U
YB	88.5	U	U	D	D	D	U	U	U
ZZ	91.5	D	D	D	U	D	D	U	U
ZA	94.8	U	D	D	D	U	D	U	U
ZB	97.4	D	D	D	U	D	U	U	U
1Z	100.0	U	U	D	D	U	D	U	U
1A	103.5	U	D	D	D	U	U	U	U
1B	107.2	U	U	D	D	U	U	U	U
2Z	110.9	U	D	D	U	D	D	U	U
2A	114.8	U	U	D	U	D	D	U	U
2B	118.8	U	D	D	U	D	U	U	U
3Z	123.0	U	U	D	U	D	U	U	U
3A	127.3	U	D	D	U	U	D	U	U
3B	131.8	U	U	D	U	U	D	U	U
4Z	136.5	U	D	D	U	U	U	U	U
4A	141.3	U	U	D	U	U	U	U	U
4B	146.2	U	D	U	D	D	D	U	U
5Z	151.4	U	U	U	D	D	D	U	U
5A	156.7	U	D	U	D	D	U	U	U
5B	162.2	U	U	U	D	D	U	U	U
6Z	167.9	U	D	U	D	U	D	U	U
6A	173.8	U	U	U	D	U	D	U	U
6B	179.9	U	D	U	D	U	U	U	U
7Z	186.2	U	U	U	D	U	U	U	U
7A	192.8	U	D	U	U	D	D	U	U
M1	203.5	U	U	U	U	D	D	U	U
M2	210.7	U	D	U	U	D	U	U	U
M3	218.1	U	U	U	U	D	U	U	U
M4	225.7	U	D	U	U	U	D	U	U
M5	233.6	U	U	U	U	U	D	U	U
M6	241.8	U	D	U	U	U	U	U	U
M7	250.3	U	U	U	U	U	U	U	U
—	None	X	X	X	X	X	X	X	D

4 & 5 Watt Models

Code (PLXXX)	Freq. Hz
001	67.0
002	71.9
N/A	N/A
003	77.0
N/A	N/A
004	82.5
N/A	N/A
005	88.5
N/A	N/A
006	94.8
N/A	N/A
N/A	N/A
007	103.5
008	107.2
009	110.9
010	114.8
011	118.8
012	123.0
013	127.3
014	131.8
015	136.5
016	141.3
017	146.2
018	151.4
019	156.7
020	162.2
021	167.9
022	173.8
023	179.9
024	186.2
025	192.8
026	203.5
027	210.7
028	218.1
029	225.7
030	233.6
031	241.8
032	250.3
000	None

Your Spirit M-Series radio is pre-set to code 29.

CODE TABLE KEY

D = Down

U = Up

X = Either Up or Down

N/A = Not Available

None = Interference Eliminator Code is off. This allows you to monitor all activity on the channel you are using.

OPERATIONS

Turn the Radio On/Off

Turn the On-Off/Volume knob clockwise. You will hear a beep and see the Transmit Light flash momentarily to indicate the radio is on. To turn the radio off, turn the On-Off/Volume knob counterclockwise. You will hear a click to indicate the radio is turned off.

Adjust the Volume

Hold Monitor button down to listen to audio level while rotating On-Off/Volume knob. Rotate knob clockwise to increase and counterclockwise to decrease volume.

To Send/Receive Messages

Check channel activity by pressing Monitor button. You will hear static if the channel is clear to use. Do not transmit if someone is talking on channel.

1. To send messages, press Push-To-Talk and speak into radio. (To maximize clarity, hold radio 1 to 2 inches from mouth). Fig. M
2. The Transmit Light will glow continuously when sending messages.
3. To listen for messages, release the Push-To-Talk button.



FIG. M

See page 15 for range information.

Time-out Timer:

The Time-out Timer feature prevents channel congestion and helps extend battery life. The radio will sound a warning tone if the Push-To-Talk button is pressed for 60 continuous seconds and will stop transmitting.

Scan (Optional)

Some M-Series models have Scan. Scan allows you to monitor the radio's programmed channels and code. When the radio detects someone talking, it stops scanning and locks in on the active channel. It allows you to listen and talk back automatically to the person transmitting without having to switch channels.

Note: To communicate in scan, your radio must be set to the same frequency and code as the other radio(s) in your group.

To Use Scan Feature

1. Move the Channel Selector knob to the "s" position (Fig. N). The radio will scan the radio's programmed channels and code in sequential order.
2. When the radio detects someone talking, you will hear the message.
3. Press Push-To-Talk button to talk back on the channel.

In scan, you will always transmit back to the channel which last sent a message.

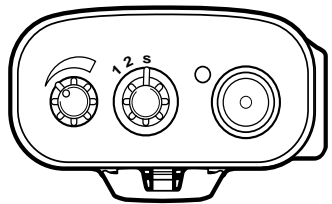

FIG. N 4 Channel Model

Notes:

- In scan, after you receive a message, the radio will remain on that channel for three seconds before returning to scan mode.
- If you set the Channel Selector knob to the "s" position (scan mode) and no activity is detected, you will transmit on channel 1 when you press the Push-To-Talk

Built-In VOX (Optional)

Some M-Series models have built-in VOX (Voice Activated Transmission). This feature allows hands-free operation of your radio. The sound of your voice activates transmission when the radio is used with a Headset With Swivel Boom Mic (HMN9038) or Earpiece With Microphone (HMN9039) (Both headset and earpiece are sold separately).

To Use VOX Feature

1. Turn the radio off.
2. Open Accessory Jack Cover and plug accessory's connector firmly into jack. Fig. 0.
3. Turn radio on and lower volume before placing accessory on head or in ear. Press Monitor button while rotating Volume knob to adjust volume to a comfortable listening level.
4. To transmit, speak into accessory microphone. To receive, stop talking.

There will be a one second delay between when you start or stop talking and radio transmission.

Exit VOX Feature

1. Press Push-To-Talk button once.
2. To transmit, press Push-To-Talk button.
3. To receive messages, release Push-To-Talk button.
4. To return to VOX mode, turn the radio off, then on again.

Note: The Accessory Jack Cover is not detachable and should be closed when not in use.

Accessories

There are many audio, charging and carrying accessories (sold separately) available for Spirit M-Series radios. Accessories allow you to customize radios to suit your business communication needs. The right accessory can enhance productivity and that can help you increase customer satisfaction.

For information, contact your place of purchase or call Motorola at:

1-800-448-6686

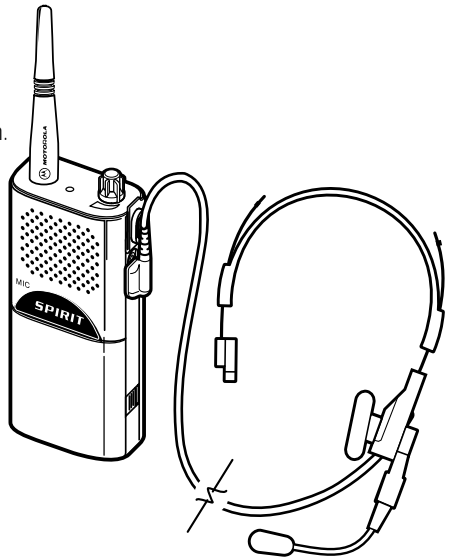

TROUBLESHOOTING

Problem	Solution
Radio Has No Power	Reposition or charge battery pack.
Battery Does Not Charge or Last Long Enough	<p>If using Charger Adapter, make sure the plug is firmly connected into jack and the light on the adapter glows indicating correct charging status.</p> <p>If Desktop Charger is used, make sure battery is positioned properly and light on tray is on.</p> <p>Radio should be turned off when charging. Charge time will be longer if it is left on.</p> <p>Heavy usage may require a spare battery or recharging.</p>
Message Not Transmitted	<p>Make sure the Push-To-Talk button is completely pressed and the Transmit Light is on while you talk.</p> <p>Insert, reposition or charge battery pack.</p>
Message Not Received	<p>Confirm radios are set on the same Channel and Interference Eliminator Code settings. See pages 8-11.</p> <p>Obstructions, operating indoors or in vehicles may interfere with communication. Change your location.</p> <p>Check to make sure the radio is on and the volume is set to a comfortable listening level.</p> <p>The code must be set to "OFF" on your radio to receive a message from a radio without code capability.</p> <p>Make sure Push-To-Talk is not inadvertently being pressed on receiving radio.</p>
Hearing Other Conversations or Noise on Radio	<p>Check that your Interference Eliminator Code is set (Active settings are 1 - 38).</p> <p>Other users may be using channel - change code. If you are part of a group, change the code on all radios.</p>
Limited Talk Range	<p>Steel/concrete structures, heavy foliage and use in buildings and in vehicles will decrease range, check for clear line of sight to improve transmission.</p> <p>Wearing radio close to body such as in a pocket or on a belt will decrease range, change location of radio.</p> <p>Radios too far apart. Obstacles interfere with transmission. Talk range is up to 5 miles in clear unobstructed conditions.</p> <p>If the radio still doesn't work properly, contact your place of purchase or call Motorola Product Services.</p>

1-800-448-6686

Radio Care

- To clean the radio housing, wipe with a soft cloth dampened with water.
- Don't use cleaners or solvents on the radio, they can harm the body and leak inside, causing permanent damage.
- Battery contacts may be wiped with a dry, lint-free cloth.

Spirit Talk Range

Spirit radios can communicate at distances of up to 5 miles. But, range will decrease as the surroundings become more obstructive.

Buildings and vehicles as well as trees and heavy foliage will limit range.

Radio Range	VHF	UHF
Maximum Range		
Outdoor- Flat Ground with no Obstructions	Up To 5 Miles	Up To 5 Miles
Medium Range		
Outdoor- Near Residential Buildings	Up To 2 Miles	Up To 2 Miles
Minimum Range		
Indoor- Steel and Concrete Reinforced Buildings	Up To 150,000 Sq. Ft	Up To 250,000 Sq. Ft
Indoor- Multi-Level Buildings	Up To 8 Floors	Up To 20 Floors

Note: The talk ranges above are averages based on field study using two watt radios. Actual radio range may vary.

SAFETY INFORMATION

Information For Safe and Efficient Operation

EXPOSURE TO RADIO FREQUENCY ENERGY

The design of your Motorola two-way radio, which generates radio frequency (RF) electromagnetic energy, complies with the following national and international standards and guidelines.

The Relevant Guidelines and Standards Are:

- FCC Report and Order FCC 96-326 (August, 1996)
- American National Standards Institute (C95-1 - 1992)
- National Council on Radiation Protection and Measurements (NCRP - 1986)
- International Commission on Non-Ionizing Radiation Protection (ICNRP - 1866)
- CENELEC
 - Env. 50166-1 1995E - Human Exposure to Electromagnetic Fields Low Frequency (0Hz to 10kHz)
 - Env. 50166-2 1995E - Human Exposure to Electromagnetic Fields High Frequency (10kHz to 300GHz)
 - Proceedings of SC.211/8 1996 - Safety Considerations for Human Exposure to EME's from Mobile Telecommunications Equipment (MTE) in the Frequency Range 30 MHz - 6 GHz (EME - Electromagnetic Fields)

To assure optimal radio performance and to insure that exposure to RF energy is within the guidelines in the above standards, the following operating procedures should be observed:

FOR PORTABLE TWO-WAY RADIOS

- **For hand-held operation:** The radio should be held in a vertical position with the microphone one to two inches away from the mouth, and the antenna should be kept one to two inches from the head or body when transmitting.



- **For body worn operation:** The antenna should be kept at least one inch from the body when transmitting.

VEHICLE-INSTALLED MOBILE TWO-WAY RADIOS

- Properly install antennas externally on the vehicle, following recommended installation procedures.
- Transmit only when people inside or outside the vehicle are at least 1 to 3 feet away from the properly installed, externally mounted antenna; distance guidelines for the different power levels are summarized in the table below:

Rated Power of Vehicle-Mounted Radio	Minimum Distance of People From Transmitting Antenna
7 to 15 Watts	1 Foot
16 to 50 Watts	2 Feet
More than 50 Watts	3 Feet

ELECTROMAGNETIC INTERFERENCE/COMPATIBILITY

Nearly every electronic device is susceptible to electromagnetic interference (EMI) if inadequately shielded, designed or otherwise configured for electromagnetic compatibility.

- Turn your radio OFF in any facilities where posted notices instruct you to do so. Hospitals or health care facilities may be using equipment that could be sensitive to external RF energy.
- Turn your radio off when on board aircraft when instructed to do so. Any use of the radio must be in accordance with airline regulations or crew instructions.

WARNING

POTENTIALLY EXPLOSIVE ATMOSPHERES

- Turn your radio OFF when in any area with a potentially explosive atmosphere, unless it is a type especially qualified for such use (for example, FMRC Approved). Sparks in such areas could cause an explosion or fire resulting in bodily injury or even death.
- Do not replace or charge batteries in a hazardous atmosphere. Contact sparking may occur while installing or removing batteries and cause an explosion.

Areas with potentially explosive atmospheres are often, but not always, clearly marked. They include fueling areas such as below deck on boats, fuel or chemical transfer or storage facilities; areas where the air contains chemicals or particles, such as grain, dust, or metal powders; and any other area where you would normally be advised to turn off your vehicle engine.

BLASTING CAPS AND AREAS

- To avoid possible interference with blasting operations, turn your radio OFF near electrical blasting caps or in a "blasting area" or in areas posted: "Turn off two-way radio". Obey all signs and instructions.

FOR VEHICLES WITH AN AIR BAG

- An air bag inflates with great force. Do not place objects, including portable or mobile two-way radios, in the area over the air bag or in the air bag deployment area. If improperly installed or placed wireless equipment is in the air bag deployment area and the air bag inflates, serious injury could result.

CAUTION

ANTENNAS

- Do not use radio with a damaged antenna. If a damaged antenna comes into contact with the skin, a minor burn may result.

BATTERIES

- All batteries can cause property damage, injury or burns if a conductive material such as jewelry, keys or beaded chains touches exposed terminals. The material may complete an electrical circuit (short circuit) and become quite hot. Exercise care in handling any charged battery, particularly when placing it inside a pocket, purse or other container with metal objects.

CAUTION

CHARGERS AND POWER CORD

- To reduce risk of damage to electric plug and cord, pull by the plug rather than the cord when disconnecting the charger.
- Make sure cord is located so that it will not be stepped on, tripped over, or otherwise subjected to damage or stress.
- Do not operate charger with damaged cord or plug, replace them immediately. Do not operate charger if it has received a sharp blow, been dropped, or otherwise damaged in any way; contact place of purchase or call 1-800-448-6686.
- Do not expose chargers to rain or snow.

An extension cord should not be used unless absolutely necessary. Use of an improper extension cord may result in a fire or electric shock. However, if an extension cord must be used, make sure:

- That pins and plug of extension cord are the same number, size and shape as those on the plug of the charger.
- That extension cord is properly wired and in good condition.
- Cord size is 18AWG for lengths of up to 100 feet, and 16AWG for lengths up to 150 feet.
- Do not disassemble charger; contact place of purchase or call 1-800-448-6686 if charger is not functioning. Incorrect reassembly can result in electric shock or fire.
- To reduce risk of injury, charge only Motorola Ni-Cad rechargeable batteries. Other types of batteries may burst, causing personal injury and damage.
- Use of an attachment not sold or recommended by Motorola can result in a risk of fire, electric shock, or injury to personnel.
- To reduce risk of electric shock, unplug charger from outlet before cleaning. Turning off controls does NOT reduce this risk.

ONE YEAR LIMITED WARRANTY

Spirit M-Series radios and accessories have a one (1) year limited warranty.

Limited Warranty Motorola Communication Products

This warranty applies within the fifty (50) United States and the District of Columbia.

I. WHAT THIS WARRANTY COVERS AND FOR HOW LONG:

MOTOROLA INC. ("MOTOROLA") warrants the MOTOROLA products listed below in the product warranty schedule section of this warranty document ("Product") against defects in material and workmanship under normal use and service for a period of time from the date of purchase as scheduled below: MOTOROLA, at its option, will, at no charge, either repair the Product (with new or reconditioned parts), replace it (with a new or reconditioned Product), or refund the purchase price of the Product during the warranty period provided it is returned in accordance with the terms of this warranty. Replaced parts or boards are warranted for the balance of the original applicable warranty period. All replaced parts of Product shall become the property of MOTOROLA.

This express limited warranty is extended by MOTOROLA to the original end user purchaser only and is not assignable or transferable to any other party. This is the complete warranty for the Product manufactured by MOTOROLA. MOTOROLA assumes no obligations or liability for additions or modifications to this warranty unless made in writing and signed by an officer of MOTOROLA. Unless made in a separate agreement between MOTOROLA and the original end user purchaser, MOTOROLA does not warrant the installation, maintenance or service of the Product.

MOTOROLA cannot be responsible in any way for any ancillary equipment not furnished by MOTOROLA which is attached to or used in connection with the Product, or for operation of the Product with any ancillary equipment, and all such equipment is expressly excluded from this warranty. Because each system which may use the Product is unique, MOTOROLA disclaims liability for range, coverage, or operation of the system as a whole under this warranty.

II. GENERAL PROVISIONS:

This warranty sets forth the full extent of MOTOROLA's responsibilities regarding the Product. Repair, replacement or refund of the purchase price, at MOTOROLA'S option, is the exclusive remedy. THIS WARRANTY IS GIVEN IN LIEU OF ALL OTHER EXPRESS WARRANTIES. IMPLIED WARRANTIES, INCLUDING WITHOUT LIMITATION IMPLIED WARRANTIES OF MERCHANTABILITY AND FITNESS FOR A PARTICULAR PURPOSE, ARE LIMITED TO THE DURATION OF THIS LIMITED WARRANTY. IN NO EVENT SHALL MOTOROLA BE LIABLE FOR DAMAGES IN EXCESS OF THE PURCHASE PRICE OF THE PRODUCT, FOR ANY LOSS OF USE, LOSS OF TIME, INCONVENIENCE, COMMERCIAL LOSS, LOST PROFITS OR SAVINGS OR OTHER INCIDENTAL, SPECIAL OR CONSEQUENTIAL DAMAGES ARISING OUT OF THE USE OR INABILITY TO USE SUCH PRODUCT, TO THE FULL EXTENT SUCH MAY BE DISCLAIMED BY LAW.

III. STATE LAW RIGHTS:

SOME STATES DO NOT ALLOW THE EXCLUSION OR LIMITATION OF INCIDENTAL OR CONSEQUENTIAL DAMAGES, OR LIMITATION ON HOW LONG AN IMPLIED WARRANTY LASTS, SO THE ABOVE LIMITATIONS OR EXCLUSIONS MAY NOT APPLY.

This warranty gives specific legal rights, and there may be other rights which may vary from state to state.

IV. HOW TO GET WARRANTY SERVICE:

To receive warranty service, deliver or send the Product item, transportation and insurance prepaid, to the place of purchase along with your proof of purchase or lease and Product item serial number. For other locations, alternatively call:

1-800-448-6686



MOTOROLA

V. WHAT THIS WARRANTY DOES NOT COVER:

- a) Defects or damage resulting from use of the Product in other than its normal and customary manner.
- b) Defects or damage from misuse, accident, liquid, or neglect.
- c) Defects or damage from improper testing, operation, maintenance, installation, alteration, modification, or adjustment.
- d) Breakage or damage to antennas unless caused directly by defects in material workmanship.
- e) A Product subjected to unauthorized Product modifications, disassemblies or repairs (including, without limitation, the addition to the Product of non-Motorola supplied equipment) which adversely affect performance of the Product or interfere with Motorola's normal warranty inspection and testing of the Product to verify any warranty claim.
- f) Product which has had the serial number removed or made illegible.
- g) Rechargeable batteries if:
 - 1) any of the seals on the battery enclosure of cells are broken or show evidence of tampering.
 - 2) the damage or defect is caused by charging or using the battery in equipment or service other than the Product for which it is specified.
- h) Freight costs to the repair depot.
- i) A Product which, due to illegal or unauthorized alteration of the software/firmware in the Product, does not function in accordance with Motorola's published specifications or the FCC type acceptance labeling in effect for the Product at the time the Product was initially distributed from Motorola.
- j) Scratches or other cosmetic damage to Product surfaces that does not effect operation of the Product.
- k) Normal and customary wear and tear.

VI. PATENT AND SOFTWARE PROVISIONS:

MOTOROLA will defend, at its own expense, any suit brought against the end user purchaser to the extent that it is based on a claim that Product or parts infringe a United States patent, and MOTOROLA will pay those costs and damages finally awarded against the end user purchaser in any such suit which are attributable to any such claim, but such defense and payments are conditioned on the following:

- a) that MOTOROLA will be notified promptly in writing by such purchaser of any notice of such claim;
- b) that MOTOROLA will have sole control of the defense of such suit and all negotiations for its settlement or compromise; and
- c) should the Product or parts become, or in MOTOROLA's opinion be likely to become, the subject of a claim of infringement of a United States patent, that such purchaser will permit MOTOROLA, at its option and expense, either to procure for such purchaser the right to continue using the Product or parts or to replace or modify the same so that it becomes non-infringing or to grant such purchaser a credit for the Product or parts as depreciated and accept its return. The depreciation will be an equal amount per year over the lifetime of the Product or parts as established by MOTOROLA.

MOTOROLA will have no liability with respect to any claim of patent infringement which is based upon the combination of the Product or parts furnished hereunder with software, apparatus or devices not furnished by MOTOROLA, nor will MOTOROLA have any liability for the use of ancillary equipment or software not furnished by MOTOROLA which is attached to or used in connection with the Product. The foregoing states the entire liability of MOTOROLA with respect to infringement of patents by the Product or any parts thereof.

Laws in the United States and other countries preserve for MOTOROLA certain exclusive rights for copyrighted MOTOROLA software such as the exclusive rights to reproduce in copies and distribute copies of such Motorola software. MOTOROLA software may be used in only the Product in which the software was originally embodied and such software in such Product may not be replaced, copied, distributed, modified in any way, or used to produce any derivative thereof. No other use including, without limitation, alteration, modification, reproduction, distribution, or reverse engineering of such MOTOROLA software or exercise of rights in such MOTOROLA software is permitted. No license is granted by implication, estoppel or otherwise under MOTOROLA patent rights or copyrights.

VII. PRODUCT WARRANTY SCHEDULE:

Spirit Radios: One (1) year

Spirit Accessories: One (1) year.

Rechargeable Batteries will be replaced during the applicable warranty period if:

- a) the battery capacity falls below 80% of rated battery capacity or,
- b) the battery develops leakage.

RECYCLING

Recycling of Nickel-Cadmium Batteries

Nickel-cadmium (Ni-Cad) rechargeable batteries can be recycled. However, recycling facilities may not be available in all areas. Under various U.S. state laws, Ni-Cad batteries must be recycled or disposed of properly and cannot be disposed of in landfills or incinerators.

Motorola fully endorses and encourages the recycling of Ni-Cad batteries. In the U.S. and Canada, Motorola participates in the nationwide Rechargeable Battery Recycling Corporation (RBRC) program for nickel-cadmium battery collection and recycling. Many retailers participate in the program. For the name of the retailer nearest your location, call 1-800-BATTERY. This number also provides access to other useful information for consumers, businesses and governmental agencies concerning recycling options.



MOTOROLA



Communication Solutions for Workgroups



MOTOROLA

Multi-channel model shown on cover.



* 6 8 8 0 9 0 5 2 7 0 *