

# *User Guide*

*QIP27xx Series*

*Set-Top Terminals*

*Standard-Definition*

*Watch and Record DVR*



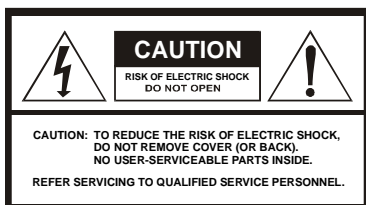

Graphical symbols and supplemental warning marking locations on bottom of terminal.

#### **WARNING**

TO REDUCE THE RISK OF FIRE OR ELECTRIC SHOCK HAZARD, DO NOT EXPOSE THIS APPLIANCE TO RAIN OR MOISTURE.

#### **CAUTION**

**TO PREVENT ELECTRICAL SHOCK, DO NOT USE THIS (POLARIZED) PLUG WITH AN EXTENSION CORD, RECEPTACLE, OR OTHER OUTLET UNLESS THE BLADES CAN BE FULLY INSERTED TO PREVENT BLADE EXPOSURE.**



The lightning flash with arrowhead symbol, within an equilateral triangle, is intended to alert the user to the presence of uninsulated "dangerous voltage" within the product's enclosure that may be of sufficient magnitude to constitute a risk of electric shock to persons.



The exclamation point, within an equilateral triangle, is intended to alert the user to the presence of important operating and maintenance (servicing) instructions in the literature accompanying the appliance.

**Product identification and supply rating is provided on the label found on the bottom of the unit.**

**This installation should be made by a qualified service person and should conform to all local codes.**

#### **REPAIRS**

If you find the unit in need of repair, contact your system operator for repair or replacement.

#### **NOTE TO SYSTEM INSTALLER**

This reminder is provided to call the system installer's attention to Article 820-40 of the NEC that provides guidelines for proper grounding and, in particular, specifies that the cable ground shall be connected to the grounding system of the building, as close as possible to the point of cable entry as practical.

# IMPORTANT SAFETY INSTRUCTIONS

- 1** Read these instructions.
- 2** Keep these instructions.
- 3** Heed all warnings.
- 4** Follow all instructions.
- 5** Do not use this apparatus near water.
- 6** Clean only with dry cloth.
- 7** Do not block any ventilation openings. Install in accordance with the manufacturer's instructions.
- 8** Do not install near any heat sources such as radiators, heat registers, stoves, or other apparatus (including amplifiers) that produce heat.
- 9** Do not defeat the safety purpose of the polarized or grounding-type plug. A polarized plug has two blades with one wider than the other. A grounding-type plug has two blades and a third grounding prong. The wide blade or the third prong is provided for your safety. If the provided plug does not fit into your outlet, consult an electrician for replacement of the obsolete outlet.
- 10** Protect the power cord from being walked on or punched particularly at plugs, convenience receptacles, and the point where they exit from the apparatus.
- 11** Use only attachments/accessories specified by the manufacturer.
- 12** Unplug this apparatus during lightning storms or when unused for long periods of time.
- 13** Refer all servicing to qualified service personnel. Servicing is required when the apparatus has been damaged in any way, such as power-supply cord or plug is damaged, liquid has been spilled or objects have fallen into the apparatus, the apparatus has been exposed to rain or moisture, does not operate normally, or has been dropped.

# Regulatory Information

## Federal Communications Commission Radio and Television Interface Statement for a Class 'B' Device

This equipment has been tested and found to comply with the limits for a Class B digital device, pursuant to part 15 of the FCC Rules. These limits are designed to provide reasonable protection against harmful interference in the residential installation. This equipment generates, uses and can radiate radio frequency energy and, if not installed and used in accordance with the instructions, may cause harmful interference to radio communications. However, there is no guarantee that interference will not occur in a particular installation.

If the equipment does cause harmful interference to radio or television reception, which can be determined by turning the equipment off and on, the user is encouraged to try to correct the interference by one of the following measures:

- Increase the separation between the equipment and the affected receiver
- Connect the equipment on a circuit different from the one the receiver is on
- Ensure that the cover plate for the security card is secured and tight

Changes or modification not expressly approved by the party responsible for compliance could void the user's authority to operate the equipment.

## Declaration of Conformity

According to 47 CFR, Parts 2 and 15 for Class B Personal Computers and Peripherals; and/or CPU Boards and Power Supplies used with Class B Personal Computers, Motorola, Inc., 6450 Sequence Drive, San Diego, CA 92121, 1-800-225-9446, declares under sole responsibility that the product identifies with 47 CFR Part 2 and 15 of the FCC Rules as a Class B digital device. Each product marketed is identical to the representative unit tested and found to be compliant with the standards. Records maintained continue to reflect the equipment being produced can be expected to be within the variation accepted, due to quantity production and testing on a statistical basis as required by 47 CFR 2.909. Operation is subject to the following condition: This device must accept any interference received, including interference that may cause undesired operation. The above named party is responsible for ensuring that the equipment complies with the standards of 47 CFR, Paragraphs 15.101 to 15.109. The Class B digital apparatus meets all requirements of the Canadian Interface Causing Equipment Regulations.

### U.S. GOVERNMENT RESTRICTED RIGHTS

The Product and documentation is provided with RESTRICTED RIGHTS. The use, duplication or disclosure by the Government is subject to restrictions as set forth in subdivision (c)(1)(ii) of The Rights in Technical Data and Computer Software clause at 52.227-7013. The contractor/manufacturer is Motorola, Inc., Broadband Communications Sector, 101 Tournament Drive, Horsham, PA 19044.

## Canadian Compliance

This Class B digital apparatus complies with Canadian ICES-003. Cet appareil numérique de la classe B est conforme à la norme NMB-003 du Canada.

# Software License

**IMPORTANT:** PLEASE READ THIS SOFTWARE LICENSE ("LICENSE") CAREFULLY BEFORE YOU USE ANY SOFTWARE, FIRMWARE AND RELATED DOCUMENTATION ("SOFTWARE") PROVIDED WITH MOTOROLA'S DIGITAL CABLE RECEIVER OR HOME THEATER SYSTEM (EACH SHALL BE REFERRED TO IN THIS LICENSE AS A "RECEIVER"). BY USING THE RECEIVER AND/OR USING ANY OF THE SOFTWARE, YOU INDICATE YOUR ACCEPTANCE OF EACH OF THE TERMS OF THIS LICENSE. UPON ACCEPTANCE, THIS LICENSE WILL BE A LEGALLY BINDING AGREEMENT BETWEEN YOU AND MOTOROLA. THE TERMS OF THIS LICENSE APPLY TO YOU AND TO ANY SUBSEQUENT USER OF THIS SOFTWARE.

IF YOU DO NOT AGREE TO ALL OF THE TERMS OF THIS LICENSE (I) DO NOT USE THE SOFTWARE AND (II) RETURN THE RECEIVER AND THE SOFTWARE (COLLECTIVELY, "PRODUCT"), INCLUDING ALL COMPONENTS, DOCUMENTATION AND ANY OTHER MATERIALS PROVIDED WITH THE PRODUCT, TO YOUR POINT OF PURCHASE OR SERVICE PROVIDER, AS THE CASE MAY BE, FOR A FULL REFUND.

The Software includes associated media, any printed materials, and any "on-line" or electronic documentation. Software provided by third parties may be subject to separate end-user license agreements from the manufacturers of such Software. The Software is never sold. Motorola licenses the Software to the original customer and to any subsequent licensee for personal use only on the terms of this License. Motorola and its third party licensors retain the ownership of the Software.

## SOFTWARE LICENSE

### You may:

USE the Software only in connection with the operation of the Product.

TRANSFER the Software (including all component parts and printed materials) permanently to another person, but only if the person agrees to accept all of the terms of this License. If you transfer the Software, you must at the same time transfer the Product and all copies of the Software (if applicable) to the same person or destroy any copies not transferred.

TERMINATE this License by destroying the original and all copies of the Software (if applicable) in whatever form.

### You may not:

(1) Loan, distribute, rent, lease, give, sublicense or otherwise transfer the Software, in whole or in part, to any other person, except as permitted under the TRANSFER paragraph above. (2) Copy or translate the User Guide included with the Software, other than for personal use. (3) Copy, alter, translate, decompile, disassemble or reverse engineer the Software, including but not limited to, modifying the Software to make it operate on non-compatible hardware. (4) Remove, alter or cause not to be displayed, any copyright notices or startup message contained in the Software programs or documentation. (5) Export the Software or the Product components in violation of any United States export laws.

The Product is not designed or intended for use in on-line control of aircraft, air traffic, aircraft navigation or aircraft communications; or in design, construction, operation or maintenance of any nuclear facility.

**MOTOROLA AND ITS THIRD PARTY LICENSORS DISCLAIM ANY EXPRESS OR IMPLIED WARRANTY OF FITNESS FOR SUCH USES. YOU REPRESENT AND WARRANT THAT YOU SHALL NOT USE THE PRODUCT FOR SUCH PURPOSES.**

Title to this Software, including the ownership of all copyrights, mask work rights, patents, trademarks and all other intellectual property rights subsisting in the foregoing, and all adaptations to and modifications of the foregoing shall at all times remain with Motorola and its third party licensors. Motorola retains all rights not expressly licensed under this License. The Software, including any images, graphics, photographs, animation, video, audio, music and text incorporated therein is owned by Motorola or its third party licensors and is protected by United States copyright laws and international treaty provisions. Except as otherwise expressly provided in this License, the copying, reproduction, distribution or preparation of derivative works of the Software, any portion of the Product or the documentation is strictly prohibited by such laws and treaty provisions. Nothing in this License constitutes a waiver of Motorola's rights under United States copyright law.

This License and your rights regarding any matter it addresses are governed by the laws of the Commonwealth of Pennsylvania, without reference to conflict of laws principles. THIS LICENSE SHALL TERMINATE AUTOMATICALLY if you fail to comply with the terms of this License.

Motorola is not responsible for any third party software that is provided as a bundled application, or otherwise, with the Software or that is downloaded to, or otherwise installed on, the Product.

# Contact Us

For technical support of your set-top, call Motorola Support at **1-866-668-2271** or **1-866-MOT-BCS1**.

For questions about your TV service, call your local service provider.

For Motorola consumer products, education, and support:

<http://www.motorola.com/broadband>

UNCONTROLLED  
DOCUMENT

---

Copyright © 2006 by Motorola, Inc. All rights reserved. No part of this publication may be reproduced in any form or by any means or used to make any derivative work (such as translation, transformation or adaptation) without written permission from Motorola, Inc.

MOTOROLA and the Stylized M Logo are registered in the US Patent & Trademark Office. Dolby Digital manufactured under license from Dolby Laboratories Licensing Corporation. Dolby, ProLogic, and the double-D symbol are registered trademarks of Dolby Laboratories Licensing Corporation. Verizon is a registered trademark of Verizon Trademark Services LLC. HDMI, the HDMI logo and High-Definition Multimedia Interface are trademarks or registered trademarks of HDMI Licensing LLC.

All other product or service names are the property of their respective owners.

Motorola reserves the right to revise this publication and to make changes in content from time to time without obligation on the part of Motorola to provide notification of such revision or change. Motorola provides this guide without warranty of any kind, either implied or expressed, including, but not limited to, the implied warranties of merchantability and fitness for a particular purpose. Motorola may make improvements or changes in the product(s) described in this manual at any time.

This device incorporates a copyright protection technology that is protected by U.S. patents and other intellectual property rights. Use of the copyright protection technology is granted by Macrovision for home and other limited pay-per-view uses only, unless otherwise authorized by Macrovision. Reverse engineering or disassembly is prohibited.

U.S. Patent Nos. 4631603, 4557216, 4819098 licensed for limited pay-per-view uses only.

## CONTENTS

Introduction .....	3
QIP27xx — Front and Back Panels .....	4
Front Panel .....	4
Front Panel Description .....	4
Back Panel .....	5
Back Panel Description.....	5
Operation .....	6
Turning Power On and Off.....	6
Changing Channels.....	6
Adjusting the Volume.....	6
Electronic Program Guide .....	6
Digital Video Recorder (DVR) – QIP27xx models only .....	7
What is DVR? .....	7
Record Programming .....	7
Maintain a Personal Program Library .....	7
Control Live TV.....	7
Simultaneously Watch Two Programs.....	7
Simultaneous Watch and Record.....	7
Simultaneously Record Two Shows .....	8
Simultaneously Record Shows and Watch a Recorded Program.....	8
On-Screen Graphics .....	12
Connecting Your Set-Top.....	12
Important Safety Considerations .....	13
Video Connection Options .....	14
Recording Your Connections .....	15
Connecting an A/V Receiver — Audio Only.....	16
Connecting your Set-Top to a Stereo TV.....	17
Connecting a Stereo TV .....	18



Connecting your Set-Top to a Stereo TV and Stereo VCR .....	19
Connecting a Stereo TV and Stereo VCR.....	20
Connecting your Set-Top to an A/V Receiver, TV, and VCR.....	21
Connecting an A/V Receiver, TV, and VCR.....	22
Data Devices .....	23
Data Features .....	23
Troubleshooting .....	24

UNCONTROLLED  
DOCUMENT

## **INTRODUCTION**

Congratulations on receiving a Motorola QIP27xx Series Standard-Definition Set-top Terminal. This product will enable you to enjoy the outstanding quality of all-digital audio and video, as offered in either standard-definition formats. In addition, the QIP27xx offers full DVR functionality to record and play back the shows you want to watch. With its second tuner, the QIP27xx also allows “watch and record” capabilities so you can really take control of your viewing options.

Based on specific configuration by your local service provider, the set-tops offer on-screen graphics to support an Electronic Program Guide (EPG). These products also support Pay-Per-View (PPV), Video-on-Demand (VoD), and other services offered by your local service provider.

The QIP27xx set-tops are equipped with a full range of audio, video, and data connections.

This User Guide introduces you to the basic features of the QIP27xx set-top, outlines important safeguards, and provides several options for integrating this component into your current entertainment system. The configuration diagrams, on-screen menu description, and troubleshooting section will help you make the most of your home entertainment experience.

To determine which features of digital TV are provided in your service area, please check with your local service provider. They will be happy to provide instructions for these optional services.

## QIP27xx — Front and Back Panels

### Front Panel

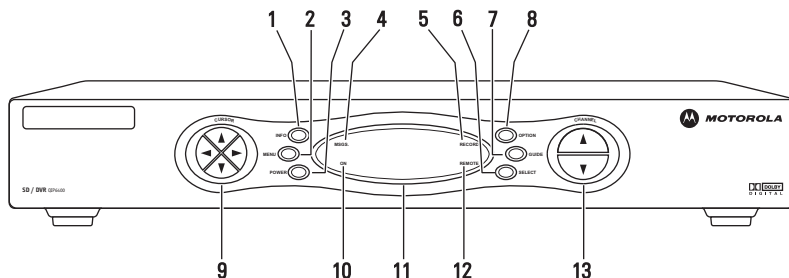

### Front Panel Description

Item	Description
1	INFO switch — Displays current channel and program information
2	MENU switch — Displays the menu area
3	POWER switch — Turns the QIP27xx on or off
4	MSG. indicator — Is lit when a message is waiting
5	RECORD indicator — Is lit when the DVR is recording (QIP27xx models <i>only</i> )
6	SELECT switch — Used for selecting menu options
7	GUIDE switch — Displays the electronic program guide
8	OPTION — Used for menu options
9	CURSOR — Moves cursor around program guide and menu screens (left, right, up, down)
10	ON — Indicates power is on when lit
11	DISPLAY — Displays channel number and time of day
12	REMOTE indicator — Is lit when remote control is in use
13	CHANNEL — Scrolls up or down through the channels

## Back Panel

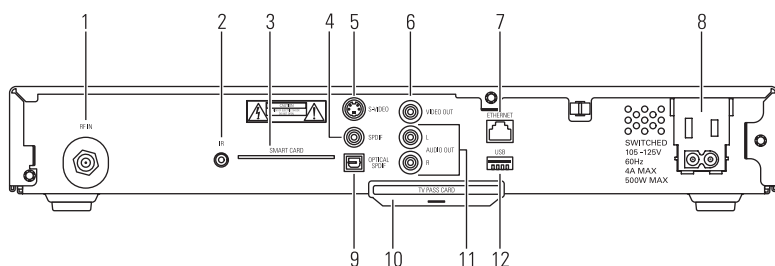

## Back Panel Description

Item	Description
1	RF IN — Connects to digital TV input from your service provider
2*	IR — Enables QIP27xx to control a VCR while recording a selected program (not supported by all program guides)
3	SMART CARD — Supports Smart Card interface (currently not enabled)
4	SPDIF (coaxial) — Provides Dolby® Digital 5:1 audio (surround sound) or PCM audio
5	S-VIDEO — Connects to S-Video input of TV or VCR
6*	VIDEO OUT — Delivers composite video to an external device, such as a TV or VCR
7	ETHERNET — (reserved)
8	AC SWITCHED OUTLET — Connects AC power cord from another device, such as a TV or VCR
9	OPTICAL SPDIF — Provides Dolby Digital 5.1 audio (surround sound) or PCM audio
10*	TVPC — TV pass card (For future use)
11	AUDIO OUT (Left and Right aligned vertically) — Connect to baseband audio input of a stereo receiver
12	USB PORT — Connects to support USB 2.0 devices. Check with your service provider for details.

*\* These features require EPG software support to enable and may or may not be functional. Check with your local service provider to see which features are enabled.*



## OPERATION

### Turning Power On and Off

Press **POWER** on the front panel to turn the set-top on or off. When using the remote control, be sure you press **CABLE** before pressing **POWER**.

### Changing Channels

You can change channels in two ways:

- Press **CHANNEL ▲** or **▼** on the front panel of the set-top, or press **CHANNEL +** or **-** on the remote control to step through the channel selection.
- Enter the number of the channel you wish to view using the number keys on the remote control.

### Adjusting the Volume

Press **VOLUME +** or **-** on the remote control to adjust the volume. When you adjust the volume, the volume scale is displayed on the screen. Press **MUTE** on the remote control to turn the sound off and on again.

For best audio quality, use the remote control to set the set-top to approximately  $\frac{3}{4}$  of the maximum volume level, and then adjust the audio levels on external devices, such as your TV or A/V Receiver.

### Electronic Program Guide

The Electronic Program Guide (EPG) displays information about TV programs and enables you to access features such as Parental Control or Pay-Per-View. EPGs can vary in look and feel, depending on your service provider. Refer to the EPG manual supplied by your service provider for detailed instructions.

## DIGITAL VIDEO RECORDER (DVR) – QIP27XX MODELS ONLY

The QIP27xx is equipped with an internal hard drive for digital video recording of standard definition TV (SDTV) programs. Storage time depends on the video format of the received program.

### What is DVR?

DVR, which stands for digital video recorder, records and plays digital video using hard-disk drive technology. Unlike an analog cassette tape, the QIP27xx's hard drive allows recording and playback to occur simultaneously.

*A DVR offers the ability to control your viewing experience by pausing (time shifting) live TV and providing trick playback modes (pause, fast forward, slow forward, fast rewind, slow rewind). You may experience a slight delay between time-shifted and live TV.*

With the QIP27xx, you can:

#### Record Programming

Record many hours of TV program content. The total hours of recorded content varies, depending on the storage capacity of your QIP27xx and the type of content being recorded.

#### Maintain a Personal Program Library

Maintain a personal library of recorded programming, accessed by using the electronic program guide (EPG)

#### Control Live TV

Pause, rewind, and fast-forward to the present time

#### Simultaneously Watch Two Programs

Watch two programs and easily switch between them using the **SWAP** key on your remote control (dependent upon program guide support and remote control)

#### Simultaneous Watch and Record

Record up to two programs in the background while viewing live or previously recorded content at the same time



**MOTOROLA**

### Simultaneously Record Two Shows

Record two programs from two different channels at the same time

### Simultaneously Record Shows and Watch a Recorded Program

Watch a program recorded on your QIP27xx while recording up to two other programs at the same time. You can also easily switch between viewing the pre-recorded program and either of the programs that you are recording.

*Refer to your service provider's instructions for the menu-driven recording and viewing options available on your set-top.*

UNCONTROLLED  
DOCUMENT

This screen appears if the HDMI port is *not* active:

<b>USER SETTINGS</b>	
<b>TV TYPE</b>	<b>16:9 (4.3 LETTERBOX, 4:3 PAN/SCAN)</b>
<b>4:3 OVERRIDE</b>	<b>480i (480p, STRETCH, OFF)</b>
<b>CLOSED CAPTION</b>	<b>DISABLED</b>
SERVICE SELECTION	
ANALOG	CC1
DIGITAL	PRIMARY LANGUAGE
FONT SIZE	AUTO
FONT STYLE	AUTO
FONT COLOR	AUTO
FONT OPACITY	AUTO
FONT EDGE TYPE	AUTO
FONT EDGE COLOR	AUTO
BACKGROUND COLOR	AUTO
BACKGROUND OPACITY	AUTO
SETTINGS	AUTO
<b>RESTORE ALL DEFAULTS</b>	

- 1 Use the remote control or the CURSOR keys on the front panel to navigate the on-screen display:
  - Press the ▲ and ▼ keys to highlight the setting you wish to change. Press the ► key to select an option for that setting.
  - To exit the setting and move to another setting, use the ▲ and ▼ keys.
- 2 To exit the menu and save your settings, press the **POWER** or **MENU** key.

*The user settings will also be displayed on the front panel display whether your TV is on or off. Use the QIP27xx front panel display to view and change your settings.*



## User Settings

Setting	Description
<b>TV TYPE</b>	<p>Sets the aspect ratio. The front panel display indicates the type you select. The default is 16:9.</p> <p>Options are 16:9 for wide screen TVs, or 4:3 LETTERBOX or 4:3 PAN/SCAN for standard TVs:</p> <ul style="list-style-type: none"><li>• 4:3 LETTERBOX fits wide screen programming on the screen by placing black bars at the top and bottom.</li><li>• 4:3 PAN/SCAN fills the screen by cropping the left and right edges of wide screen programming.</li></ul>
<b>4:3 OVERRIDE</b>	<p>Sets the display format for 4:3 standard-definition programming. Options are:</p> <ul style="list-style-type: none"><li>• <b>OFF</b> displays non-high-definition programs having a 4:3 aspect ratio in widescreen format. Selecting OFF for a 4:3 TV may result in a small picture with black bars around it.</li><li>• <b>480i</b> displays non-high-definition programs in their original 480i format. Check the TV's user manual for more information.</li><li>• <b>Stretch</b> automatically stretches all standard definition programming to fill your wide screen display. Stretch can only be selected if you have TV Type set to 16:9.</li></ul>
<b>CLOSED CAPTION</b>	<p>Turns closed captions on or off. The front panel display indicates the status of the closed captions. Options are ENABLED or DISABLED. The default is DISABLED.</p>
<b>SERVICE SELECTION</b>	<p>Sets the service used for closed captions:</p> <ul style="list-style-type: none"><li>• <b>Analog:</b> CC1, CC2, CC3, CC4, T1, T2, T3, or T4. The default is CC1.</li><li>• <b>Digital:</b> PRIMARY LANGUAGE, SECONDARY LANGUAGE, 3, 4, 5, or 6. The default is PRIMARY LANGUAGE.</li></ul>
<b>FONT SIZE</b>	<p>Sets the font size for closed captions. Options are AUTO, STANDARD, LARGE, or SMALL. The default is AUTO.</p>
<b>FONT STYLE</b>	<p>Sets the font style for closed captions. Options are AUTO, MONO SERIF, PROPORTION SERIF, MONO NO SERIF, PROPORTION NO SERIF, CASUAL, CURSIVE, or SMALL. The default is AUTO.</p>

Setting	Description
FONT COLOR	Sets the font color for closed captions — AUTO, WHITE, BLACK, RED, GREEN, BLUE, YELLOW, MAGENTA, or CYAN. The default is AUTO.
FONT OPACITY	Sets the opacity for closed captions — AUTO, TRANSPARENT, TRANSLUCENT, SOLID, or FLASHING. The default is AUTO.
FONT EDGE TYPE	Sets the edge appearance for closed captions — AUTO, NONE, RAISED, DEPRESSED, UNIFORM, LEFT SHADOWED, or RIGHT SHADOWED. The default is AUTO.
FONT EDGE COLOR	Sets the edge color for closed captions — AUTO, WHITE, BLACK, RED, GREEN, BLUE, YELLOW, MAGENTA, or CYAN. The default is AUTO.
BACKGROUND COLOR	Sets the background color for closed captions. Options are AUTO, WHITE, BLACK, RED, GREEN, BLUE, YELLOW, MAGENTA, or CYAN. The default is AUTO.
BACKGROUND OPACITY	Sets the background opacity for closed captions. Options are AUTO, TRANSPARENT, TRANSLUCENT, SOLID, or FLASHING. The default is AUTO.
SETTINGS	Sets the default settings for closed captions (AUTO) or the settings you have configured (USER). Options are AUTO or USER. The default is AUTO.
<b>RESTORE ALL DEFAULTS</b>	<p>Resets the on-screen display options to their default settings.</p> <p>To reset all User Settings to their defaults, select this option and press the ► key.</p>



## ON-SCREEN GRAPHICS

The QIP27xx can generate graphics that overlay the video programming or fill the entire television screen. Common examples include on-screen menus (such as the User Setting menu), closed captions, and electronic program guides. The QIP27xx overlays these graphics whenever you open a menu, enable closed captions, or scroll through a program grid.

## CONNECTING YOUR SET-TOP

This section describes how to connect the QIP27xx set-top to your home entertainment system.

Instructions and diagrams are included for the following connections to the QIP27xx:

- Standard-Definition Television (SDTV)
- A/V Receiver — Audio
- Stereo TV
- Stereo TV and Stereo VCR
- A/V Receiver, TV, and VCR
- Stereo TV and VCR

Before you move or change components on your entertainment system, review the following:

- For basic RF connections, use 75-ohm coaxial cables equipped with F-type connectors.
- Disconnect power from the set-top before connecting or changing any connections.

### CAUTION!



*Do not place anything on top of the set-top, especially other home entertainment components. Be sure to provide adequate ventilation to prevent overheating.*

## Important Safety Considerations

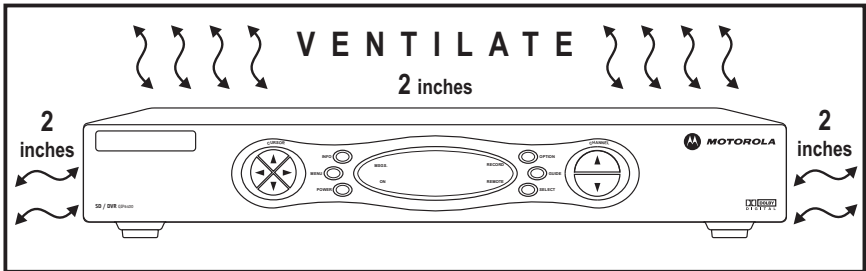

Follow these important safety guidelines when positioning and connecting the set-top:

- Position the set-top with at least two inches of space above and on all sides.
- Do not block the slots and openings on the set-top.
- Do not place anything on top of the set-top.
- Do not position the set-top in an enclosed space that would restrict airflow around the unit.
- Do not position the set-top near any external heat source that could raise the temperature around the unit. Do not place the set-top on top of another heat-producing electronic device.
- Allow for adequate ventilation around the set-top to maintain normal operating temperature. Do not place the set-top in a sealed enclosure without providing for adequate airflow.
- Do not plug the AC power cord into a switched power outlet.



## Video Connection Options

The QIP27xx offers Composite video, S-video, and RF coaxial connections to allow you to view standard definition TV programming

Use these guidelines to determine the best video connection for your home entertainment system, and then refer to the table that follows for specific procedures that apply to specific setups.

- **S-Video — SDTV**

If component video connections are not available on your TV, use the S-VIDEO connection.

- **Video** (also referred to as composite video) — **SDTV**

If S-Video is not available, use the composite video (VIDEO) connection.

- **RF Output — SDTV**

If your TV has an RF input only, connect it to the RF output on the set-top. The TV must be tuned to channel 3 or 4.

If You Have:

Follow:

**Stereo TV only**

Connecting Your Set-Top to a Stereo TV

**Stereo TV and  
Stereo VCR**

Connecting your Set-Top to a Stereo TV and Stereo VCR

**Stereo TV,  
Stereo VCR, and  
A/V Receiver**

Connecting your Set-Top to an A/V Receiver, TV, and VCR

## RECORDING YOUR CONNECTIONS

Use this diagram to record connections between your home entertainment components. You can use this diagram to reconnect your system if you move the equipment or add new equipment.

Disconnect the power from the set-top before connecting or changing any connections. Do not place another component or object on top of the set-top.

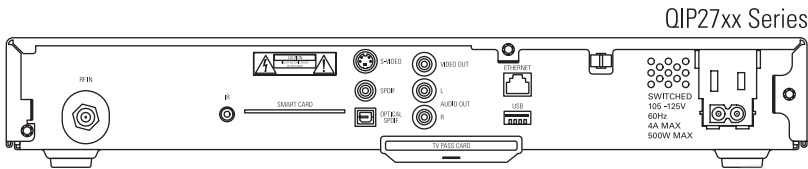

VCR

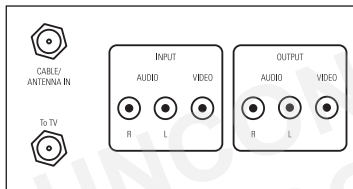

SDTV

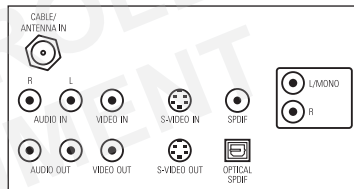

Stereo receiver

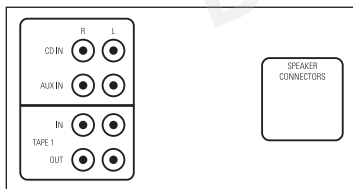

DVD

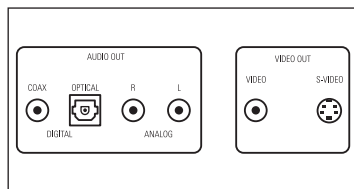

Home theater/digital receiver

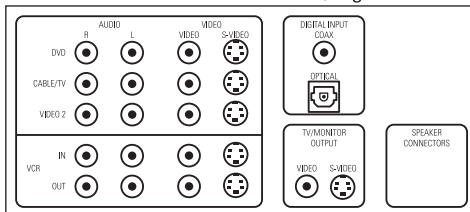



## Connecting an A/V Receiver — Audio Only

There are three options available for audio connections to your A/V receiver:

- Optical (**OPTICAL SPDIF**)
- Coaxial (**SPDIF**)
- Stereo audio (**AUDIO R** and **L**)

If your equipment supports it, the optical (**OPTICAL SPDIF** connector) or coaxial (**SPDIF** connector) audio outputs may be used in place of the stereo audio outputs (**AUDIO R** and **L**). In most cases, these outputs offer a higher level of audio quality, including support for Dolby Digital 5.1 surround sound.

- **Optical SPDIF:** Connect the optical SPDIF cable to the **OPTICAL SPDIF** connector on the set-top and to the **OPTICAL** connector on the A/V receiver.
- **SPDIF (coaxial):** Connect the digital audio cable to the **SPDIF** connector on the set-top and to the **DIGITAL INPUT COAX** connector on the A/V receiver.
- **Stereo audio:** Connect the stereo audio cable to the **AUDIO R** and **L** connectors on the set-top and to the **AUDIO LEFT** and **AUDIO RIGHT** connectors on the A/V receiver.

## CONNECTING YOUR SET-TOP TO A STEREO TV



RF (75 ohm) connector



S-Video connector



Video connector



Audio connector

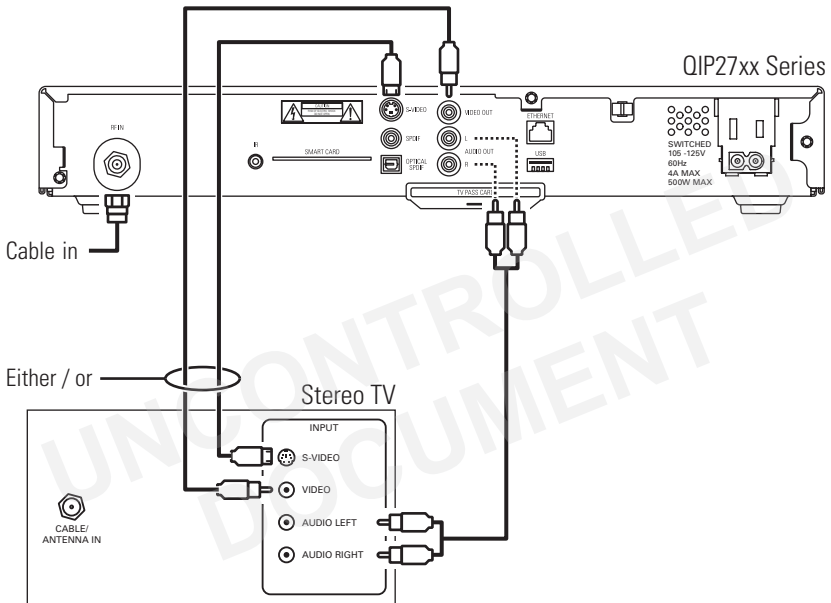



## Connecting a Stereo TV

- 1 Connect an RF coaxial cable to the service provider's wall outlet and to the **RF IN** connector on the set-top.
- 2 Connect the stereo audio cable to the **AUDIO R** and **L** connectors on the set-top and to the **AUDIO LEFT** and **AUDIO RIGHT** connectors on the stereo TV.
- 3 Connect a video cable to the **VIDEO OUT** connector on the set-top and to the **INPUT VIDEO** on the TV. Or, connect an S-video cable to the **S-VIDEO** connectors on the set-top and the TV.

UNCONTROLLED  
DOCUMENT

**CONNECTING YOUR SET-TOP TO A STEREO TV AND STEREO VCR**



RF (75 ohm)  
connector



Video  
connector



Audio  
connector

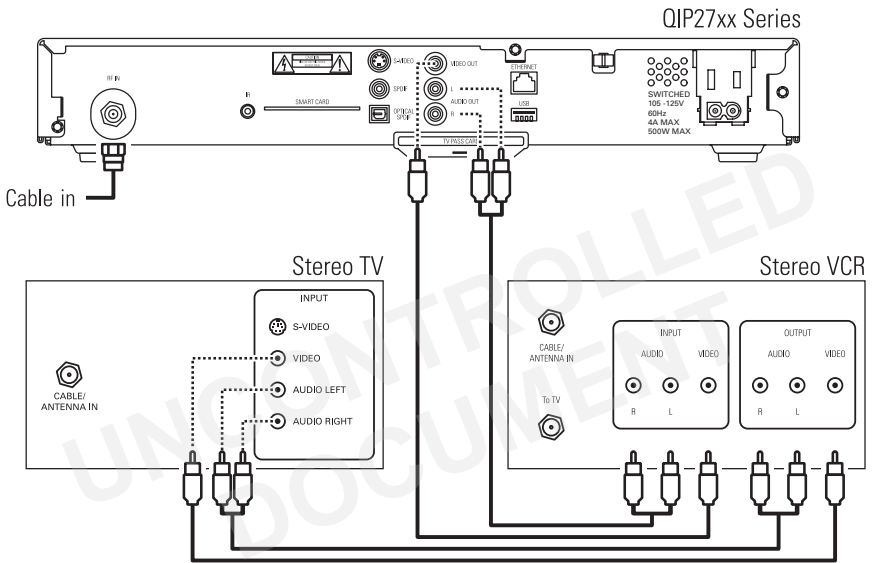



## Connecting a Stereo TV and Stereo VCR

- 1 Connect an RF coaxial cable to the service provider's wall outlet and to the **CABLE IN** connector on the set-top.
- 2 Connect a stereo audio cable to the **AUDIO OUT R** and **L** connectors on the set-top and to the **INPUT AUDIO R** and **L** connectors on the stereo VCR.
- 3 Connect a video cable to the **VIDEO OUT** connector on the set-top and to the **INPUT VIDEO** connector on the stereo VCR.
- 4 Connect a stereo audio cable to the **OUTPUT AUDIO R** and **L** connectors on the Stereo VCR and to the **INPUT AUDIO R** and **L** connectors on the stereo TV.
- 5 Connect a video cable to the **OUTPUT VIDEO** connector on the stereo VCR and to the **INPUT VIDEO** connector on the stereo TV.

UNCONTROLLED  
DOCUMENT

## CONNECTING YOUR SET-TO TO AN A/V RECEIVER, TV, AND VCR

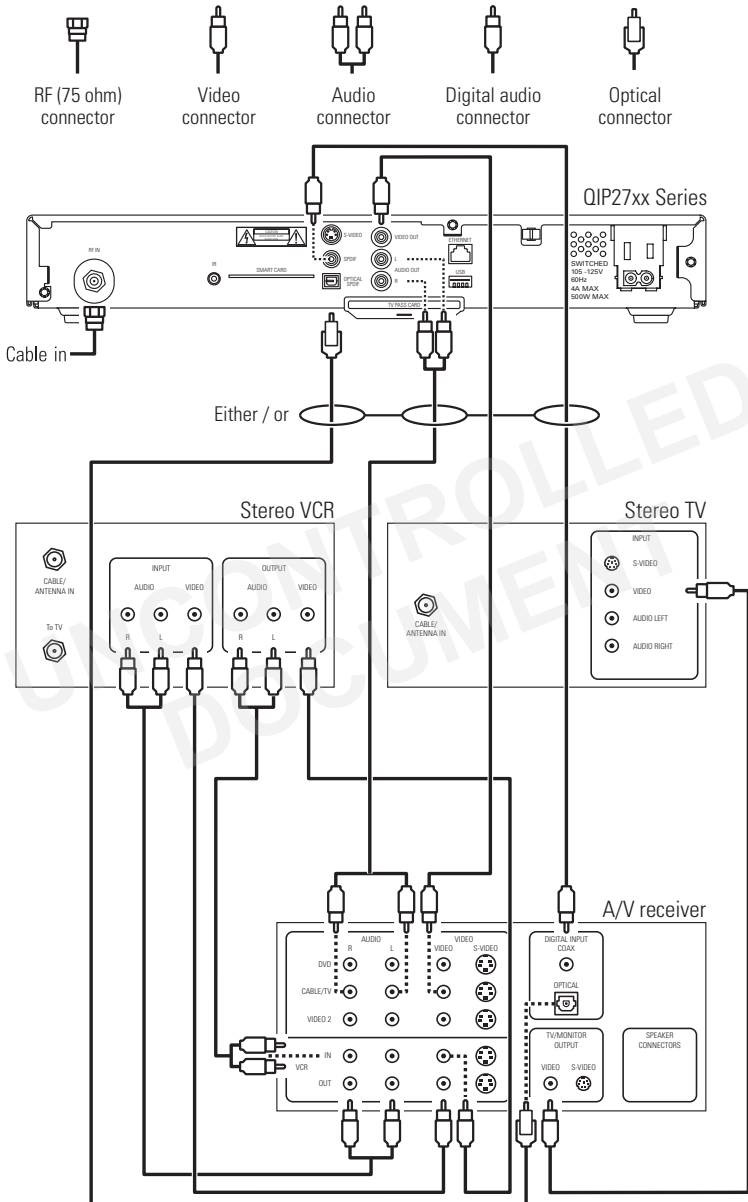



## Connecting an A/V Receiver, TV, and VCR

If your equipment supports it:

- The optical (square **SPDIF** connector) or coaxial (round **SPDIF** connector) audio outputs may be used in place of the stereo audio outputs (**AUDIO R** and **L**). In most cases, these outputs offer a higher level of audio quality, including support for Dolby Digital 5:1 surround sound.
  - S-video connections may be used in place of the standard RCA video connections. In most cases, S-video offers a higher level of standard definition video quality than RCA video.
- 1 Connect an RF coaxial cable to the service provider's wall outlet and to the **CABLE IN** connector on the set-top.
  - 2 Connect a stereo audio cable to the **AUDIO OUT R** and **L** connectors on the set-top and to the **INPUT R** and **L** connectors on the A/V receiver.
  - 3 Connect a video cable to the **VIDEO OUT** connector on the set-top and to the **CABLE/TV VIDEO** connector on the A/V receiver.
  - 4 Connect a stereo audio cable to the **VCR AUDIO OUT R** and **L** connectors on the A/V receiver and to the **INPUT AUDIO R** and **L** connectors on the stereo VCR.
  - 5 Connect a stereo audio cable to the **OUTPUT AUDIO OUT R** and **L** connectors on the stereo VCR and to the **VCR AUDIO IN R** and **L** connectors on the A/V receiver.
  - 6 Connect a video cable to the **INPUT VIDEO** connector on the stereo VCR and to the **VIDEO VCR OUT** connector on the A/V receiver.
  - 7 Connect a video cable to the **OUTPUT VIDEO** connector on the stereo VCR and to the **VIDEO VCR IN** connector on the A/V receiver.
  - 8 Connect a video cable to the **INPUT VIDEO** connector on the stereo TV and to the **TV/MONITOR OUTPUT VIDEO** connector on the A/V receiver.

## DATA DEVICES

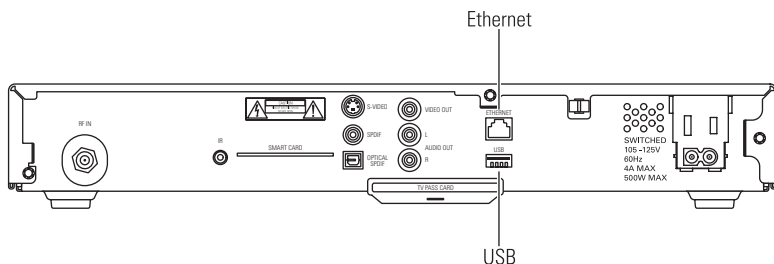

*Do not attempt to connect data devices without contacting your service provider. Advanced data features require the proper application and network infrastructure to operate.*

### Data Features

In addition to high quality audio and video, the set-top has the capability to support the following data interfaces: USB 2.0, Ethernet.

Your set-top may be equipped with the interface connections illustrated, but their functionality depends on the services offered by your service provider.



## TROUBLESHOOTING

Before calling your service provider, review this troubleshooting guide. This information is to help you quickly solve a problem. If your problem persists, contact your service provider.

<b>Problem</b>	<b>Possible Solution</b>
<b>The set-top will not power on</b>	<p>The set-top may have received a software update and may not power on while the new software is being installed. Try again in a few minutes.</p> <p>Verify that the AC power cord is connected to the set-top and an AC outlet. Unplug the set-top from the AC outlet, plug it back in, and then press the <b>POWER</b> button.</p> <p>If the set-top is connected to a switched outlet on another unit, verify that that unit is powered on. Unplug the set-top from the AC outlet, plug it back in, and then press the <b>POWER</b> button.</p> <p>Press the <b>POWER</b> button on the set-top front panel instead of the remote control. The batteries in the remote control may be depleted.</p>
<b>The remote control does not work</b>	<p>Verify that the remote control is in "Cable" mode.</p> <p>Verify that there are no obstructions between the remote control and the set-top. Aim the remote control directly at the set-top front panel, not the TV or VCR.</p> <p>The angle between the remote control and the set-top may be too large. Stand in front of the set-top and not too far to either side.</p> <p>Press and release operation keys one at a time, firmly and deliberately.</p> <p>Try changing channels using the buttons on the set-top front panel.</p> <p>Check the batteries in the remote control. Install new batteries if needed.</p>

<b>Problem</b>	<b>Possible Solution</b>
<b>There is no audio when viewing channels</b>	<p>Verify that the <b>MUTE</b> button on the set-top or the remote control has not been pressed. Press <b>MUTE</b> on the remote control to restore sound.</p> <p>If the set-top audio output is connected to the TV, verify that the <b>MUTE</b> button on the TV has not been pressed.</p> <p>If the set-top audio output is connected to a digital/home theater receiver, verify that the receiver is set to the appropriate input source and the <b>MUTE</b> button on the receiver has not been pressed.</p> <p>Verify that you have the correct cables for the audio ports.</p> <p>Verify that the audio cables are firmly connected between the set-top and the audio playback device (TV, receiver, DVD player, etc.).</p>
<b>There is no audio from the center and/or surround speakers of a digital/home theater receiver connected to the set-top</b>	<p>Not all Dolby Digital programs feature full 5:1 surround sound. In some cases, the programs may only contain left and right stereo audio.</p> <p>Verify that the SPDIF cable (round coaxial connector or square optical connector) is firmly connected to the set-top and the home theater receiver.</p> <p>Verify that the home theater receiver is set to a surround sound audio mode (Dolby Digital, Dolby Pro Logic® II, Dolby Pro Logic).</p> <p>Verify that the receiver is properly configured to work with all connected speakers.</p>



<b>Problem</b>	<b>Possible Solution</b>
<b>There is no video on the TV screen</b>	<p>Verify that the TV is powered on and set to the appropriate input source for the set-top.</p> <p>Verify that the set-top is powered on and tuned to an authorized digital TV channel.</p> <p>Verify that all video cables between the set-top and the TV are firmly connected.</p> <p>Verify that the coaxial cable feed is firmly connected to the set-top and the wall jack.</p> <p>If the set-top video output is connected to a home theater receiver, verify that the home theater receiver is powered on and set to the appropriate input source.</p>
<b>The set-top is making a humming noise.</b>	<p>The set-top includes an integrated hard drive and a fan for cooling. During normal operation, the set-top emits a low humming noise, similar to a personal computer. The noise varies in volume occasionally when the speed of the internal fan adjusts to changes in the temperature around the set-top. Please note the hard drive will stay on even when the set-top is turned off.</p>

UNCONFIDENTIAL DOCUMENT

UNCONTROLLED  
DOCUMENT

Visit our website at:  
[www.motorola.com](http://www.motorola.com)



531634-001-a  
6/06