

TalkAbout™

DISTANCE/DPS

Owner's Manual

Channel	MHz
1	462.5625
2	462.5875
3	462.6125
4	462.6375
5	462.6625
6	462.6875
7	462.7125
A	462.5750
B	462.6250
C	462.6750 (Emergency Channel)
S	Scan

Interference Eliminator Code Chart					
TalkAbout Codes	HZ Frequency	Sport 77X Codes	TalkAbout Codes	HZ Frequency	Sport 77X Codes
1	..67.0		20	..131.8	
2	..71.9		21	..136.5G
3	..74.4		22	..141.3	
4	..77.0A	23	..146.2	
5	..79.7		24	..151.4	
6	..82.5		25	..156.7	
7	..85.4		26	..162.2	
8	..88.5B	27	..167.9	
9	..91.5		28	..173.8	
10	..94.8		29	..179.9	
11	..97.4C	30	..186.2	
12	..100.0		31	..192.8	
13	..103.5		32	..203.5	
14	..107.2D	33	..210.7	
15	..110.9		34	..218.1	
16	..114.8		35	..225.7	
17	..118.8E	36	..233.6	
18	..123.0		37	..241.8	
19	..127.3F	38	..250.3	
OFF				None

Note: *OFF* means you can hear all activity on the channel.

Specifications

Description	Specs
Channels	10
Codes	38
Operating Frequency	UHF - 462.5625 to 462.7125 MHz
Talk Range	Up to 5 Miles
Power Source	6 AA Alkaline Batteries or 1 Ni-Cad Battery Pack
Battery Life	25 Hrs Alkaline Batteries, 8 Hrs Ni-Cad Battery (5/5/90 duty cycle)

Shown on Cover: TalkAbout Distance DPS and TalkAbout Distance

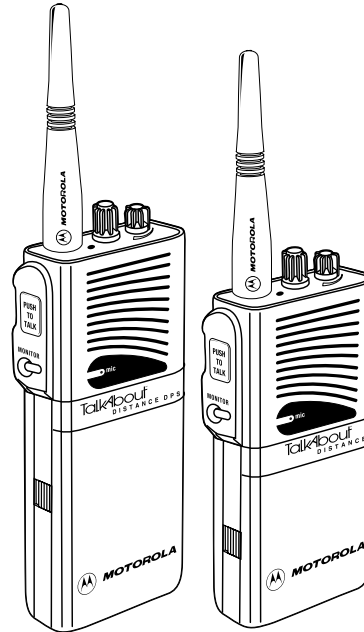

Copyright Information

The Motorola products described in this manual may include copyrighted Motorola programs stored in semiconductor memories or other media. Laws in the United States and other countries, preserve for Motorola, certain exclusive rights for copyrighted computer programs, including the exclusive right to copy or reproduce in any form, the copyrighted Motorola programs. Accordingly, any copyrighted Motorola computer programs contained in the Motorola products described in this manual may not be copied or reproduced in any manner without the express written permission of Motorola. Furthermore, the purchase of Motorola products shall not be deemed to grant either directly or by implication, estoppel, or otherwise, any license under the copyrights, patents or patent applications of Motorola, except for the normal non-exclusive royalty free license to use that arises by operation of law in the sale of a product.

To help you easily locate important information in this manual, the following icons are used to signal warnings and cautions.

Here's what the symbols mean:

 **CAUTION**

Indicates a potentially hazardous situation which, if not avoided, may result in minor or moderate injury.

 **WARNING**

Indicates a potentially hazardous situation which, if not avoided, may result in death or serious injury.

Please see pages 14 and 15 for complete information.

FCC Licensing Information	2
Getting Started	
Your New Radio	3
Contents Of Package	3
TalkAbout Distance Radio	4
To Attach/Remove Antenna	5
To Attach/Remove Belt Clip	5
Batteries	6
Low Battery Alert	6
To Install/Remove Ni-Cad Battery	6
To Charge Ni-Cad Battery	7
Installing Alkaline Batteries For DPS Model	7
Programming	
Before You Can Talk	8
Interference Eliminator Codes	8
Bandwidth	8
Compatibility	8
To Change Code Settings	9
Operations	
Turn The Radio On/Off	10
Adjust The Volume	10
To Send/Receive Messages	10
Time-out Timer	10
Scan	10
Built-In VOX	11
Accessories	11
Other Information	
Troubleshooting	12
Radio Care	13
Talk Range	13
Safety Information	14-15
Warranty	16
Recycling Of Nickel-Cadmium Batteries	Inside Back Cover
Channel Frequency Chart	Back Cover
Interference Eliminator Code Chart	Back Cover
Specifications	Back Cover

FCC Licensing Information

TalkAbout Distance radios operate on General Mobile Radio Service (GMRS) frequencies which require a Federal Communications Commission (FCC) license. GMRS frequencies have been allocated by the FCC for recreational use such as camping, hunting and skiing.

For licensing information and applications (ask for forms 574 and 159) call the FCC forms hotline at:

1-800-418-FORM

(1-800-418-3676)

For questions concerning the license application, contact the FCC at:

1-888-CALL-FCC

(1-888-225-5322)

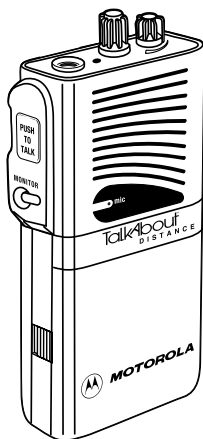

1



2



3

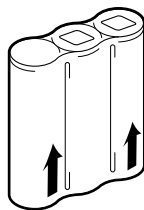

4

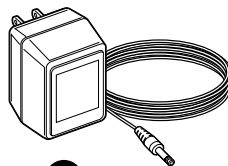

5

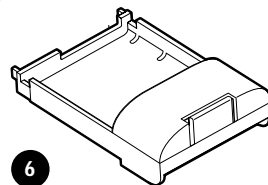

6

Included with Talkabout Distance DPS models only.

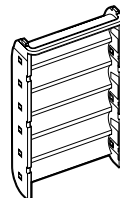

7

Included with Talkabout Distance DPS models only.

TOU NEW RADIO

Thank you for purchasing a Motorola TalkAbout Distance radio.

Please read this manual carefully to ensure you know how to properly operate the radio before use. If you have questions regarding your radio, please call Motorola at:

1-800-353-2729

CONTENTS OF PACKAGE

1. Radio
2. Antenna
3. Belt Clip
4. Ni-Cad Battery Pack
5. 10 Hour Charger Adapter
6. Ni-Cad Battery Tray - DPS Models Only
7. Alkaline Battery Tray - DPS Models Only

TalkAbout Distance Radio

1. Antenna
2. Push-To-Talk Button
3. Monitor Button
4. Microphone
5. Battery Cover
6. Battery Cover Latches
7. Speaker
8. On-Off/Volume Knob
9. Channel Selector Knob
10. Transmit Light
11. Accessory Jack
12. Accessory Jack Cover

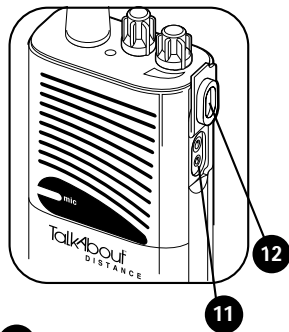
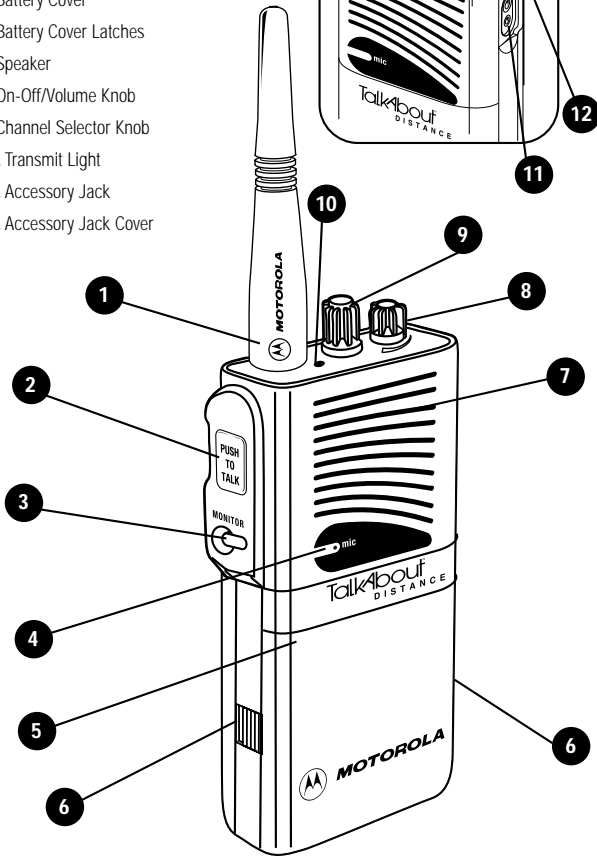

To Attach/Remove Antenna

To attach the antenna, rotate the antenna clockwise onto the top of the radio until hand tight. Reverse to remove. Fig. A

Note: The antenna should always be installed when operating the radio. Operating the radio without an antenna greatly reduces the range of the radio.

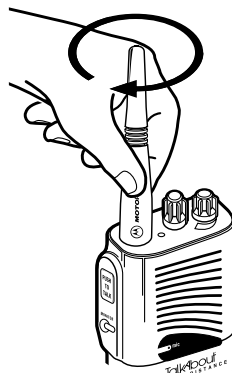

FIG. A

To Attach/Remove Belt Clip

1. Align the belt clip to the mounting rails on the back of the radio. Fig. B
2. Push the belt clip down until it clicks into place.
3. To remove, pull tab on belt clip away from radio to release. Fig. C
4. Slide belt clip up and off.

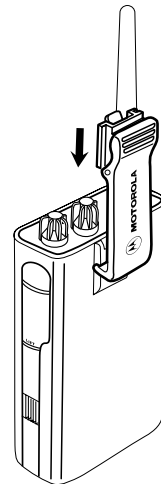

FIG. B

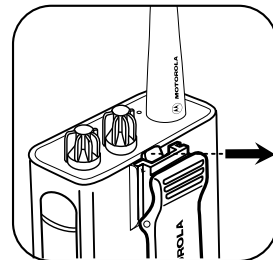

FIG. C

Batteries

The Ni-Cad battery ships uncharged, it must be fully charged for 16 hours before use (first charge only). It is recommended that only Motorola batteries and chargers be used with the radio.

The Ni-Cad rechargeable battery pack will provide approximately 8 hours of operation with normal use (5% sending messages, 5% receiving messages and 90% in standby mode).

Low Battery Alert

When the battery is low, the radio will beep:

- 3 to 4 seconds after turning power on
- Every 10 minutes in standby mode
- After release of the Push-To-Talk button

Recharge the battery pack immediately to avoid interrupted use.

Note: Remove battery pack before storing your radio for extended periods. Batteries may corrode over time if left in radio and can cause permanent damage to your radio.

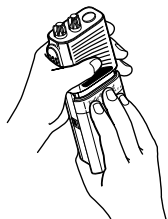

FIG. D

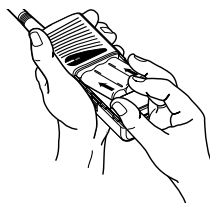

FIG. E

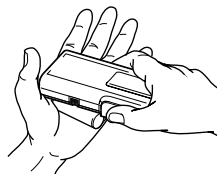

FIG. F



FIG. G

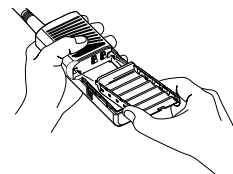

FIG. H

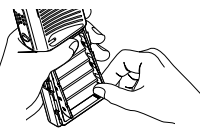

FIG. I

To Install/Remove Ni-Cad Battery

Note: Radio must be OFF before installing/removing battery.

1. Push back both battery cover latches until you see the orange tabs.
2. Slide battery cover down and lift to remove. Fig. D
3. Insert the battery pack with arrows pointing towards the top of the radio. Fig. E
4. Replace battery cover and lock latches.
5. To remove battery, remove cover, turn the radio over and tap the battery end of the radio against the palm of your hand. The battery will drop into your hand. Fig. F

Note: Do not remove the plastic wrap from the battery pack. This will permanently damage the battery.

To Charge Ni-Cad Battery

1. Turn the radio off.
2. Lift accessory cover and plug the Charger Adapter firmly into the small jack (lower hole).
3. Plug the charger into an electric outlet. The light on the charger will glow continuously if charging properly.
4. Allow 10 hours for the battery to fully charge.

Notes:

- For optimum battery life, the battery should not be left charging for prolonged periods after reaching full charge. Charging the battery over the weekend is acceptable.
- Turn radio off when charging. If radio is on while charging, at least twice as much time is required to charge the battery.

Installing Alkaline Batteries For DPS Model

Your TalkAbout Distance DPS radio has the option of operating with either a Ni-Cad battery pack or 6 AA alkaline batteries. Alkaline batteries will last about 25 hours with normal use. That's approximately 5% sending messages, 5% receiving and 90% in standby mode.

To Install Alkaline Battery Tray

1. Unlock battery cover latches and remove battery cover and Ni-Cad battery pack.
2. Remove Ni-Cad tray by squeezing latch on bottom of tray and lift out. Fig. G
3. Align the tabs on the top and sides of the alkaline battery tray with the slots in the radio. Contacts on battery tray should match contacts with radio. Fig. H
4. Press bottom of battery tray into radio.

To Remove Alkaline Battery Tray

1. Holding radio as shown in Fig. I, press thumb on top of alkaline tray to pop bottom edge out of radio.
2. Grasp the bottom edge of the tray and pull it out of the radio.

Before You Can Talk

Read this manual carefully, make sure you know how to properly operate the radio before use.

TalkAbout Distance radios have 10 channels and 38 Interference Eliminator Codes. To talk to others, all radios in your group must be set to the same channel and code (see charts on back cover).

Interference Eliminator Codes

Codes filter out static, noise and unwanted chatter on radio channels. When you operate on a channel with a code set, you block out most interference on that channel. This allows you to communicate with less interference than when operating without a code. Remember, since radio channels can be monitored, codes will not make your conversations private.

- For compatibility with radios that do not have codes, the radio can be set to Code "Off" in the programming mode.

IMPORTANT

To talk to others in your group all radios must be set to the same channel and code.

Bandwidth

In the USA, the FCC has declared that all Family Radio Service frequencies must operate on 12.5 kHz bandwidth. Your Talkabout Distance radio ships pre-set on 25.0 kHz, but can be set to 12.5 kHz while in the programming mode. Handicom/Sport 10X radios operate on 25.0 kHz as well. All other Talkabout and Sport 7/7X radios operate on 12.5 kHz bandwidth. For optimal audio quality, all radios in your talk group should be set to the same band.

Compatibility

Channels 1-7 on your TalkAbout Distance are compatible with TalkAbout/TalkAbout Plus, Sport 7/7X and 10X radios. Channels A and B are compatible with SportBASE and Sport 10X radios. The emergency channel (C) is to be used only for the purpose of soliciting or rendering assistance to a traveller, or for communicating in an emergency pertaining to the immediate safety of life or the immediate protection of property. The emergency channel is used by certain organizations during emergency situations and is not necessarily monitored. See back cover for chart of channels and codes.

IO Change Code and Bandwidth Settings

1. Hold Push-To-Talk button down while turning radio on. Fig. J
🔊 *Radio announces current code setting. Example: "code one"*
2. Press Push-To-Talk to scroll through codes. Fig. K
🔊 *Radio announces each code as you scroll. Example: "two...three...four"*
3. Release Push-To-Talk when you have reached desired code.
4. Press Monitor button to select and save new code setting. Fig. L
🔊 *Radio "beeps", then announces current band setting. Example: "band two five point zero"*
5. Press Push-To-Talk to toggle between bands. Fig. K
🔊 *Radio announces each band as you toggle. Example: "one two point five"*
6. Press Monitor button to select and save new band setting. Fig. L
🔊 *Radio "beeps" to indicate it has exited programming and is ready for use.*

Notes:

- Code numbers with two digits (10-38) will be announced "one zero...three eight".
- You can only scroll forward when selecting a code.
- When you are changing your code or band, you can not send messages.
- The code and band settings apply to all channels. You can not select a different code or band for each channel.

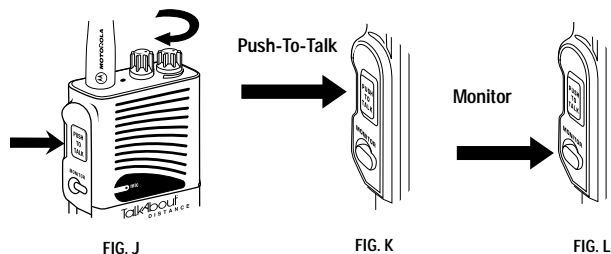

Turn the Radio On/Off

Turn the On-Off/Volume knob clockwise. You will hear a beep and see the Transmit Light flash momentarily to indicate the radio is on. To turn the radio off, turn the On-Off/Volume knob counterclockwise. You will hear a click to indicate the radio is turned off.

Adjust the Volume

Hold Monitor button down to listen to audio level while rotating On-Off/Volume knob. Rotate knob clockwise to increase and counterclockwise to decrease volume.

To Send/Receive Messages

Check channel activity by pressing Monitor button. You will hear static if the channel is clear to use. Do not transmit if someone is talking on channel.

1. To send messages, press Push-To-Talk and speak into radio. (To maximize clarity, hold radio 1 to 2 inches from mouth). Fig. M
2. The Transmit Light will glow continuously when sending messages.
3. To listen for messages, release the Push-To-Talk button.



FIG. M

See page 13 for range information.

Time-out Timer

The Time-out Timer feature prevents channel congestion and helps extend battery life. The radio will sound a warning tone if the Push-To-Talk button is pressed for 60 continuous seconds and will stop transmitting.

Scan

Scan allows you to monitor the radio's channels and code. When the radio detects someone talking, it stops scanning and locks in on the active channel. It allows you to listen and talk back automatically to the person transmitting without having to switch channels.

Note: To communicate in scan, your radio must be set to the same code as the other radio(s) in your group. If your radio is set to a different code, the scan feature will not detect channel activity in your group.

To Use Scan Feature

1. Move the Channel Selector knob to the "s" position (Fig. N). The radio will scan the radio's channels and code in sequential order.
2. When the radio detects someone talking, you will hear the message.
3. Press Push-To-Talk button to talk back on the channel. If channel activity ceases, the radio will return to scan mode after three seconds.

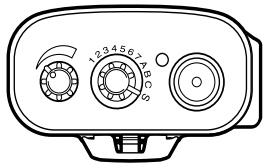

FIG. N

4. In scan, you will always transmit back to the channel which last sent a message.

Notes:

- In scan, after you receive a message, the radio will remain on that channel for three seconds before returning to scan mode.

- If you set the Channel Selector knob to the "s" position (scan mode) and no activity is detected, you will transmit on channel 1 when you press the Push-To-Talk button

Built-In VOX

The VOX (Voice Activated Transmission) feature allows hands-free operation of your radio. The sound of your voice activates transmission when the radio is used with a Headset With Swivel Boom Mic or Earbud With Inline Mic (models 50226/50256, sold separately).

To Use VOX Feature

1. Turn the radio off.
2. Open Accessory Jack Cover and plug accessory's connector firmly into jack.
3. Turn radio on and lower volume before placing accessory on head or in ear. Press Monitor button while rotating Volume knob to adjust volume to a comfortable listening level.
4. To transmit, speak into accessory microphone. To receive, stop talking.

There will be a one second delay between when you start or stop talking and radio transmission.

Exit VOX Feature

1. Press Push-To-Talk button once.
2. To transmit, press Push-To-Talk button.
3. To receive messages, release Push-To-Talk button.
4. To return to VOX mode, turn the radio off, then on again.

Note: The Accessory Jack Cover is not detachable and should be closed when not in use.

Accessories

There are many audio and carrying accessories (sold separately) available for TalkAbout Distance radios. Receive incoming messages in privacy with an Earbud. Whether it's a Belt Case, Fanny Pack or Waterproof Bag, Motorola has a great carrying case for you!

For information, contact your place of purchase or call Motorola at:

1-800-353-2729

Problem	Solution
---------	----------

Radio Has No Power	Reposition or charge Ni-Cad battery pack. Replace alkaline batteries.
--------------------	--

Ni-Cad Battery Does Not Charge or Last Long Enough	Make sure the Charger Adapter plug is firmly connected into jack and the light on the adapter glows indicating correct charging status. Radio should be turned off when charging. Charge time will be longer if it is left on. Heavy usage may require a spare battery or recharging.
--	---

Message Not Transmitted	Make sure the Push-To-Talk button is completely pressed and the Transmit Light is on while you talk. Insert, reposition or charge battery pack. Replace Alkaline batteries.
-------------------------	---

Message Not Received	Confirm radios are set on the same Channel and Interference Eliminator Code settings. See back cover. Obstructions, operating indoors or in vehicles may interfere with communication. Change your location. Check to make sure the radio is on and the volume is set to a comfortable listening level. The code must be set to "OFF" on your radio to receive a message from a radio without code capability. Make sure Push-To-Talk is not inadvertently being pressed on receiving radio.
----------------------	--

Hearing Other Conversations or Noise on Radio	Check that your Interference Eliminator Code is set (Active settings are 1 - 38). Other users may be using channel - change code. If you are part of a group, change the code on all radios.
---	---

Limited Talk Range	Steel/concrete structures, heavy foliage and use in buildings and in vehicles will decrease range, check for clear line of sight to improve transmission. Wearing radio close to body such as in a pocket or on a belt will decrease range, change location of radio. Radios too far apart. Obstacles interfere with transmission. Talk range is up to 5 miles in clear unobstructed conditions.
--------------------	---

Can Not Change Code or Bandwidth Settings in Programming	Make sure that the Push-To-Talk (PTT) button is completely pressed while turning the radio on. Insert, reposition, or charge battery pack. Replace Alkaline batteries. Press the Monitor button to save your code or band selection. Please see page 9 for more information.
--	--

If the radio still doesn't work properly, contact your place of purchase or call Motorola Product Services.

1-800-353-2729

Radio Care

- To clean the radio housing, wipe with a soft cloth dampened with water.
- Don't use cleaners or solvents on the radio, they can harm the body and leak inside, causing permanent damage.
- Battery contacts may be wiped with a dry, lint-free cloth.

Talk Range

TalkAbout Distance radios have been designed to maximize performance and improve transmission range in the field. It is recommended that you do not use the radios closer than 5 feet apart for clarity.

Talk range depends on the terrain. These are line of sight radios and talk range will be affected by concrete structures, heavy foliage and operating radios indoors and in vehicles.



Optimal Range

Talk range in flat, open areas, up to 5 miles.



Medium Range

Range is decreased when buildings and trees are in the way.



Minimal Range

Dense foliage and mountains can limit range.

Information For Safe and Efficient Operation

EXPOSURE TO RADIO FREQUENCY ENERGY

Your Motorola two-way radio, which generates and radiates radio frequency (RF) electromagnetic energy (EME), is designed to comply with the following national and international standards and guidelines regarding exposure of human beings to radio frequency electromagnetic energy:

- FCC Report and Order FCC 96-326 (August, 1996)
- American National Standards Institute (C95-1 - 1992)
- National Council on Radiation Protection and Measurements (NCRP - 1986)
- International Commission on Non-Ionizing Radiation Protection (ICNRP - 1986)
- European Committee for Electrotechnical Standardization (CENELEC)
 - Env. 50166 - 1 1995E - Human Exposure to Electromagnetic Fields Low Frequency (0Hz to 10kHz)
 - Env. 50166 - 2 1995E - Human Exposure to Electromagnetic Fields High Frequency (10kHz to 300Ghz)
- Proceeding of SC211/8 1996 - Safety Considerations for Human Exposure to E.M.F.'s from Mobile Telecommunications Equipment (M.T.E.) in the Frequency Range 30MHz - 6GHz (E.M.F.-Electromagnetic Fields)

To assure optimal radio performance and that human exposure to radio frequency electromagnetic energy is within the guidelines set forth in the above standards, always adhere to the following procedures:

FOR PORTABLE TWO-WAY RADIOS

- When transmitting with a portable radio, hold radio in a vertical position with its microphone 1 to 2 inches (2.5 to 5.0 cm) away from your mouth. Keep antenna at least 1 inch (2.5 cm) from your head and body.
- If you wear a portable radio on your body, ensure that the antenna is at least one inch (2.5 cm) from your body when transmitting.



ELECTROMAGNETIC INTERFERENCE/COMPATIBILITY

Nearly every electronic device is susceptible to electromagnetic interference (EMI) if inadequately shielded, designed or otherwise configured for electromagnetic compatibility.

- To avoid electromagnetic interference and/or compatibility conflicts, turn off your radio in any facility where posted notices instruct you to do so. Hospitals or health care facilities may be using equipment that is sensitive to external RF energy.
- When instructed to do so, turn off your radio when on board an aircraft. Any use of a radio must be in accordance with airline regulations or crew instructions.

⚠ WARNING

For Vehicles With an Air Bag

Do not place a portable radio in the area over an air bag or in the air bag deployment area. Air bags inflate with great force. If a portable radio is placed in the air bag deployment area and the air bag inflates, the radio may be propelled with great force and cause serious injury to occupants of vehicle.

Potentially Explosive Atmospheres

Turn your radio OFF when in any area with a potentially explosive atmosphere, unless it is a type especially qualified for such use (for example, Factory Mutual Approved). Sparks in such areas could cause an explosion or fire resulting in bodily injury or even death.

Batteries

Do not replace or charge batteries in a potentially explosive atmosphere. Contact sparking may occur while installing or removing batteries and cause an explosion.

Blasting Caps and Areas

To avoid possible interference with blasting operations, turn your radio OFF near electrical blasting caps or in a "blasting area" or in areas posted: "Turn off two-way radio". Obey all signs and instructions.

Note: Areas with potentially explosive atmospheres are often, but not always, clearly marked. They include fuelling areas such as below deck on boats, fuel or chemical transfer or storage facilities; areas where the air contains chemicals or particles, such as grain, dust, or metal powders; and any other area where you would normally be advised to turn off your vehicle engine.

⚠ CAUTION

Damaged Antennas

Do not use any radio that has a damaged antenna. If a damaged antenna comes in contact with the skin, a minor burn may result.

Batteries

All batteries can cause property damage and/or bodily injury such as burns if a conductive material such as jewelry, keys or beaded chains touches exposed terminals. The material may complete an electrical circuit (short circuit) and become quite hot. Exercise care in handling any charged battery, particularly when placing it inside a pocket, purse or other container with metal objects.

1 YEAR LIMITED WARRANTY

Motorola, Inc. warrants the enclosed product against defects in material and workmanship under normal use and service for one (1) year provided it is returned in accordance with this warranty. If defective, the product will be repaired or replaced at Motorola's option, at no charge, with dated proof of purchase. This warranty does not cover defects or damage resulting from: misuse, improper operation, unauthorized modification, liquid, batteries, or normal wear and tear.

MOTOROLA IS NOT LIABLE FOR DAMAGES IN EXCESS OF THE PURCHASE PRICE OF THE PRODUCT, FOR ANY INCIDENTAL OR CONSEQUENTIAL DAMAGES ARISING OUT OF THE USE OR INABILITY TO USE SUCH PRODUCT, TO THE FULL EXTENT SUCH MAY BE DISCLAIMED BY LAW. THE IMPLIED WARRANTIES OF MERCHANTABILITY AND FITNESS FOR A PARTICULAR PURPOSE ARE LIMITED TO THE DURATION OF THIS LIMITED WARRANTY. HOWEVER, SOME STATES DO NOT ALLOW LIMITATIONS ON INCIDENTAL OR CONSEQUENTIAL DAMAGES, OR LIMITATION ON HOW LONG AN IMPLIED WARRANTY LASTS, SO THE ABOVE LIMITATION MAY NOT APPLY TO YOU. THIS WARRANTY GIVES YOU SPECIFIC LEGAL RIGHTS, AND YOU MAY HAVE OTHER RIGHTS WHICH VARY FROM STATE TO STATE.

For warranty information and service call 1-800-353-2729.

Recycling of Nickel-Cadmium Batteries

Nickel-cadmium (Ni-Cad) rechargeable batteries can be recycled. However, recycling facilities may not be available in all areas. Under various U.S. state laws, Ni-Cad batteries must be recycled or disposed of properly and cannot be disposed of in landfills or incinerators. Contact your local waste management agency for specific requirements and information in your area.

Motorola fully endorses and encourages the recycling of Ni-Cad batteries. In the U.S. and Canada, Motorola participates in the nationwide Rechargeable Battery Recycling Corporation (RBRC) program for nickel-cadmium battery collection and recycling. Many retailers and dealers participate in this program. For the location of the drop off facility closest to you, see RBRC's internet website at www.rbrc.com or call 1-800-8-BATTERY. This internet site and telephone number also provides access to other useful information for consumers, businesses and governmental agencies concerning recycling options.



 , Motorola, SportBASE and TalkAbout are registered trademarks of Motorola, Inc.